

Intel® NUC Board DE3815TYBE Technical Product Specification

July 2014

Order Number: H26598-004

The Intel NUC Board DE3815TYBE may contain design defects or errors known as errata that may cause the product to deviate from published specifications. Current characterized errata are documented in the Intel NUC Board DE3815TYBE Specification Update.

Revision History

Revision	Revision History	Date
001	First release of the Intel® NUC Board DE3815TYBE Technical Product Specification	April 2014
002	Specification Clarification	April 2014
003	Specification Clarification	June 2014
004	Specification Clarification	July 2014

Disclaimer

This product specification applies to only the standard Intel® NUC Board with BIOS identifier TYBYT10H.86A.

INFORMATION IN THIS DOCUMENT IS PROVIDED IN CONNECTION WITH INTEL® PRODUCTS. NO LICENSE, EXPRESS OR IMPLIED, BY ESTOPPEL OR OTHERWISE, TO ANY INTELLECTUAL PROPERTY RIGHTS IS GRANTED BY THIS DOCUMENT. EXCEPT AS PROVIDED IN INTEL'S TERMS AND CONDITIONS OF SALE FOR SUCH PRODUCTS, INTEL ASSUMES NO LIABILITY WHATSOEVER, AND INTEL DISCLAIMS ANY EXPRESS OR IMPLIED WARRANTY, RELATING TO SALE AND/OR USE OF INTEL PRODUCTS INCLUDING LIABILITY OR WARRANTIES RELATING TO FITNESS FOR A PARTICULAR PURPOSE, MERCHANTABILITY, OR INFRINGEMENT OF ANY PATENT, COPYRIGHT OR OTHER INTELLECTUAL PROPERTY RIGHT. UNLESS OTHERWISE AGREED IN WRITING BY INTEL, THE INTEL PRODUCTS ARE NOT DESIGNED NOR INTENDED FOR ANY APPLICATION IN WHICH THE FAILURE OF THE INTEL PRODUCT COULD CREATE A SITUATION WHERE PERSONAL INJURY OR DEATH MAY OCCUR.

All Intel® NUC Boards are evaluated as Information Technology Equipment (I.T.E.) for use in personal computers (PC) for installation in homes, offices, schools, computer rooms, and similar locations. The suitability of this product for other PC or embedded non-PC applications or other environments, such as medical, industrial, alarm systems, test equipment, etc. may not be supported without further evaluation by Intel.

Intel Corporation may have patents or pending patent applications, trademarks, copyrights, or other intellectual property rights that relate to the presented subject matter. The furnishing of documents and other materials and information does not provide any license, express or implied, by estoppel or otherwise, to any such patents, trademarks, copyrights, or other intellectual property rights.

Intel may make changes to specifications and product descriptions at any time, without notice.

Designers must not rely on the absence or characteristics of any features or instructions marked "reserved" or "undefined." Intel reserves these for future definition and shall have no responsibility whatsoever for conflicts or incompatibilities arising from future changes to them.

Intel processor numbers are not a measure of performance. Processor numbers differentiate features within each processor family, not across different processor families: Go to:

[Learn About Intel® Processor Numbers](#)

Intel NUC Boards may contain design defects or errors known as errata, which may cause the product to deviate from published specifications. Current characterized errata are available on request.

Contact your local Intel sales office or your distributor to obtain the latest specifications before placing your product order.

Intel and Intel Atom are trademarks of Intel Corporation in the U.S. and/or other countries.

* Other names and brands may be claimed as the property of others.

Copyright © 2014, Intel Corporation. All rights reserved.

Board Identification Information

Basic Intel® NUC Board DE3815TYBE Identification Information

AA Revision	BIOS Revision	Notes
H26998-401	TYBYT10H.86A.0019	1,2

Notes:

1. The AA number is found on a small label on the component side of the board.
2. The Intel® Atom™ processor E3815 used on this AA revision consists of the following component:

Device	Stepping	S-Spec Numbers
Intel Atom E3815	B3	SR1RA

Specification Changes or Clarifications

The table below indicates the Specification Changes or Specification Clarifications that apply to the Intel NUC Board DE3815TYBE.

Specification Changes or Clarifications

Date	Type of Change	Description of Changes or Clarifications
April 2014	Spec Clarification	Added Table 27 Power Budget for Assessing the DC-to-DC Circuit's Power Rating (worst case: Embedded board in 3rd party chassis)
April 2014	Spec Clarification	Added Section 1.9 Audio Subsystem.
June 2014	Spec Clarification	<ul style="list-style-type: none">• Updated Figure 1 to show the location of the Power LED.• Updated Figure 2 to show the location of the HDD LED• Updated Figure 17 to correct pin locations.• Updated Table 2 and Table 10 to add 2.0 mm pitch to Serial and VGA headers.• Updated Table 2 to correct the order of the callouts.
July 2014	Spec Clarification	Added Section 1.13 Intel® Security and Manageability Technologies

Errata

Current characterized errata, if any, are documented in a separate Specification Update. See <http://www.intel.com/content/www/us/en/nuc/overview.html> for the latest documentation.

Intel NUC Board DE3815TYBE Technical Product Specification

Preface

This Technical Product Specification (TPS) specifies the board layout, components, connectors, power and environmental requirements, and the BIOS for Intel® NUC Board DE3815TYBE.

Intended Audience

The TPS is intended to provide detailed, technical information about Intel NUC Board DE3815TYBE and its components to the vendors, system integrators, and other engineers and technicians who need this level of information. It is specifically *not* intended for general audiences.

What This Document Contains

Chapter	Description
1	A description of the hardware used on Intel NUC Board DE3815TYBE
2	A map of the resources of the Intel NUC Board
3	The features supported by the BIOS Setup program
4	A description of the BIOS error messages, beep codes, and POST codes
5	Regulatory compliance and battery disposal information

Typographical Conventions

This section contains information about the conventions used in this specification. Not all of these symbols and abbreviations appear in all specifications of this type.

Notes, Cautions, and Warnings



NOTE

Notes call attention to important information.



CAUTION

Cautions are included to help you avoid damaging hardware or losing data.

Other Common Notation

#	Used after a signal name to identify an active-low signal (such as USBP0#)
GB	Gigabyte (1,073,741,824 bytes)
GB/s	Gigabytes per second
Gb/s	Gigabits per second
KB	Kilobyte (1024 bytes)
Kb	Kilobit (1024 bits)
kb/s	1000 bits per second
MB	Megabyte (1,048,576 bytes)
MB/s	Megabytes per second
Mb	Megabit (1,048,576 bits)
Mb/s	Megabits per second
TDP	Thermal Design Power
xxh	An address or data value ending with a lowercase h indicates a hexadecimal value.
x.x V	Volts. Voltages are DC unless otherwise specified.
*	This symbol is used to indicate third-party brands and names that are the property of their respective owners.

Contents

Revision History

Disclaimer	ii
Board Identification Information	iii
Errata	iii

Preface

Intended Audience.....	v
What This Document Contains.....	v
Typographical Conventions	v

1 Product Description

1.1 Overview	11
1.1.1 Feature Summary	11
1.1.2 Board Layout (Top)	13
1.1.3 Board Layout (Bottom)	15
1.1.4 Block Diagram	17
1.2 Online Support	18
1.3 Processor	18
1.4 System Memory	19
1.5 Graphics Subsystem	21
1.5.1 Integrated Graphics.....	21
1.6 USB	25
1.7 SATA Interface	25
1.7.1 SATA Disk-on-Module (DOM) Voltage Selection Header	26
1.7.2 AHCI Mode	26
1.8 Real-Time Clock Subsystem	26
1.9 Audio Subsystem.....	27
1.9.1 Audio Subsystem Software	27
1.10 LAN Subsystem	28
1.10.1 Realtek* 8111GN-CG Gigabit Ethernet Controller	28
1.10.2 LAN Subsystem Software	28
1.10.3 RJ-45 LAN Connector with Integrated LEDs	29
1.11 Hardware Management Subsystem	29
1.11.1 Hardware Monitoring	30
1.11.2 Fan Monitoring	30
1.11.3 Thermal Solution	30
1.12 Power Management	31
1.12.1 ACPI	31
1.12.2 Hardware Support	33
1.13 Intel® Security and Manageability Technologies	36

2 Technical Reference

2.1	Memory Resources	37
2.1.1	Addressable Memory	37
2.2	Connectors and Headers.....	38
2.2.1	Front Panel Connector.....	38
2.2.2	Back Panel Connectors.....	38
2.2.3	Headers (Top)	39
2.2.4	Connectors and Headers (Bottom).....	40
2.3	BIOS Security Jumper	52
2.4	Mechanical Considerations	54
2.4.1	Form Factor.....	54
2.5	Electrical Considerations.....	55
2.5.1	Power Supply Considerations	55
2.5.2	Fan Header Current Capability	55
2.6	Thermal Considerations	56
2.7	Reliability.....	59
2.8	Environmental.....	59

3 Overview of BIOS Features

3.1	Introduction.....	61
3.2	BIOS Flash Memory Organization.....	61
3.3	System Management BIOS (SMBIOS)	61
3.4	Legacy USB Support	62
3.5	BIOS Updates	62
3.5.1	Language Support	63
3.5.2	Custom Splash Screen	63
3.6	BIOS Recovery.....	64
3.7	Boot Options.....	65
3.7.1	Network Boot.....	65
3.7.2	Booting Without Attached Devices	65
3.7.3	Changing the Default Boot Device During POST.....	65
3.8	Hard Disk Drive Password Security Feature.....	67
3.9	BIOS Security Features	68

4 Error Messages and Blink Codes

4.1	Front-panel Power LED Blink Codes.....	69
4.2	BIOS Error Messages	69

5 Regulatory Compliance and Battery Disposal Information

5.1	Regulatory Compliance.....	71
5.1.1	Safety Standards.....	71
5.1.2	European Union Declaration of Conformity Statement.....	72
5.1.3	Product Ecology Statements.....	73
5.1.4	EMC Regulations.....	73
5.1.5	e-Standby and ErP Compliance.....	76
5.1.6	Regulatory Compliance Marks (Board Level).....	77
5.2	Battery Disposal Information.....	78

Figures

1.	Major Board Components (Top).....	13
2.	Major Board Components (Bottom).....	15
3.	Block Diagram.....	17
4.	Memory Channel and SO-DIMM Configuration.....	20
5.	Flat Panel Connectors.....	23
6.	4-Pin 3.5 mm (1/8 inch) Audio Jack Pin Out.....	27
7.	LAN Connector LED Locations.....	29
8.	Thermal Solution and Fan Header.....	30
9.	Location of the Standby Power LED.....	35
10.	Front Panel Connector.....	38
11.	Back Panel Connectors.....	38
12.	Header (Top).....	39
13.	Connectors and Headers (Bottom).....	40
14.	Connection Diagram for the Front Panel Dual-Port USB 2.0 Header.....	46
15.	Connection Diagram for the Front Panel USB 2.0 Single-Port Header.....	46
16.	Connection Diagram for the Internal Power Supply Connector.....	47
17.	Connection Diagram for Front Panel Header.....	48
18.	Connection Diagram for Stereo Speaker Header.....	49
19.	Custom Solutions Header.....	51
20.	Location of the BIOS Security Jumper.....	52
21.	Board Dimensions.....	54
22.	Localized High Temperature Zones.....	57

Tables

1.	Feature Summary.....	11
2.	Components Shown in Figure 1.....	14
3.	Components Shown in Figure 2.....	16
4.	Supported Memory Configurations.....	19
5.	SATA DOM Voltage Selection Header.....	26
6.	LAN Connector LED States.....	29
7.	Effects of Pressing the Power Switch.....	31
8.	Power States and Targeted System Power.....	32
9.	Wake-up Devices and Events.....	33

Intel NUC Board DE3815TYBE Technical Product Specification

10.	Header Shown in Figure 12	39
11.	Connectors and Headers Shown in Figure 13.....	41
12.	PCI Express Half-Mini Card Connector	42
13.	Internal Stereo Speaker Header	42
14.	Serial Port Header	43
15.	Front Panel Dual-Port USB 2.0 Header.....	43
16.	Front Panel Single-Port USB 2.0 Header	43
17.	Custom Solutions Header	43
18.	VGA Header	44
19.	SATA Connector	44
20.	SATA Power Connector.....	44
21.	Flat Panel Voltage Selection Header	44
22.	Backlight Inverter Voltage Selection Header.....	45
23.	30-Pin eDP Connector	45
24.	Internal Power Supply Connector Pinout	47
25.	Front Panel Header	48
26.	BIOS Security Jumper Settings.....	53
27.	Power Budget for Assessing the DC-to-DC Circuit's Power Rating (worst case: Embedded board in 3 rd party chassis)	55
28.	Fan Header Current Capability	55
29.	Thermal Considerations for Components.....	58
30.	Tcontrol Values for Components	58
31.	Environmental Specifications.....	59
32.	Acceptable Drives/Media Types for BIOS Recovery.....	64
33.	Boot Device Menu Options	65
34.	Master Key and User Hard Drive Password Functions	67
35.	Supervisor and User Password Functions	68
36.	Front-panel Power LED Blink Codes.....	69
37.	BIOS Error Messages	69
38.	Safety Standards.....	71
39.	EMC Regulations.....	73
40.	Regulatory Compliance Marks	77

1 Product Description

1.1 Overview

1.1.1 Feature Summary

Table 1 summarizes the major features of the board.

Table 1. Feature Summary

Form Factor	4.0 inches by 4.0 inches (101.60 millimeters by 101.60 millimeters)
Processor	<ul style="list-style-type: none">• Soldered-down Intel® Atom™ processor E3815 with up to ~5 W TDP<ul style="list-style-type: none">– Integrated graphics– Integrated memory controller– Integrated PCH
Memory	<ul style="list-style-type: none">• Support for DDR3L 1066 MHz SO-DIMM• Support for 1 Gb, 2 Gb, and 4 Gb memory technology• Support for up to 8 GB of system memory with one SO-DIMM using 4 Gb memory technology• Support for non-ECC memory• Support for 1.35 V low voltage JEDEC memory• One 4 GB Embedded MultiMediaCard (e-MMC) device in a Ball Grid Array (BGA) package
Graphics	<ul style="list-style-type: none">• Integrated graphics support with Intel® Graphics Technology:<ul style="list-style-type: none">– Digital displays (High Definition Multimedia Interface* (HDMI*))– Analog displays (VGA)• Flat panel displays via the internal Embedded DisplayPort* (eDP) connector
Audio	<ul style="list-style-type: none">• Intel® High Definition Audio via the HDMI v1.4a interface• Realtek ALC283 audio codec providing:<ul style="list-style-type: none">– High Definition Audio via a stereo microphone/headphone jack on the back panel– Internal stereo speaker header– Support for digital microphone (DMIC) via internal header
Peripheral Interfaces	<ul style="list-style-type: none">• USB ports:<ul style="list-style-type: none">– Two USB 2.0 back panel connectors– Two front panel USB 2.0 ports are implemented through a dual-port internal header– One front panel USB 2.0 port is implemented through a single-port internal header– One USB 3.0 front panel connector– One port is reserved for the PCI Express* Half-Mini Card• SATA ports:<ul style="list-style-type: none">– One SATA 3.0 Gb/s port
Expansion Capabilities	One PCI Express Half-Mini Card connector
BIOS	<ul style="list-style-type: none">• Intel® BIOS resident in the Serial Peripheral Interface (SPI) Flash device• Support for Advanced Configuration and Power Interface (ACPI), Plug and Play, and System Management BIOS (SMBIOS)

continued

Table 1. Feature Summary (continued)

LAN Support	Gigabit (10/100/1000 Mb/s) LAN subsystem using the Realtek* 8111GN-CG Gigabit Ethernet Controller
Hardware Monitor Subsystem	Hardware monitoring subsystem, based on an ITE IT8607E embedded controller, including: <ul style="list-style-type: none">• Voltage sense to detect out of range power supply voltages• Thermal sense to detect out of range thermal values• One processor fan header• Fan sense input used to monitor fan activity• Simple fan speed control

1.1.2 Board Layout (Top)

Figure 1 shows the location of the major components on the top-side of Intel NUC Board DE3815TYBE.

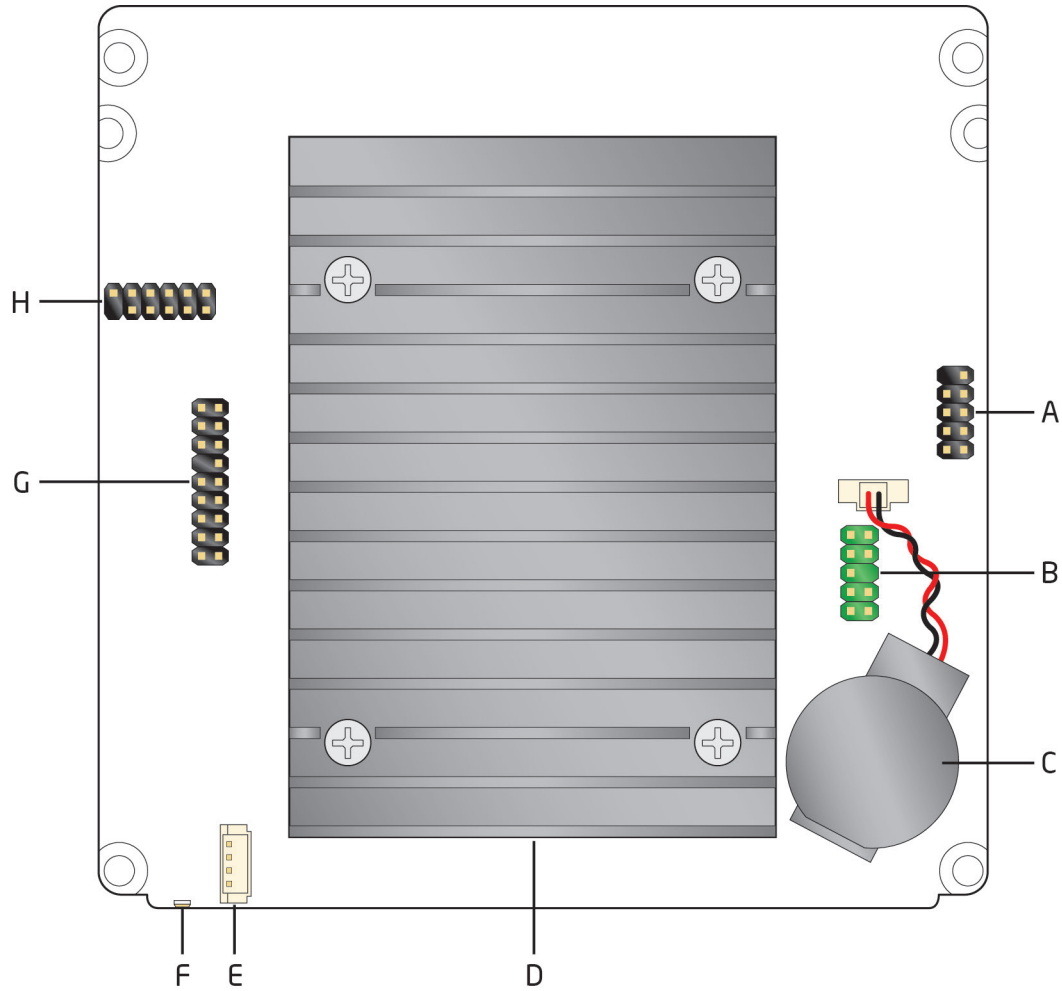

OM24059

Figure 1. Major Board Components (Top)

Table 2 lists the components identified in Figure 1.

Table 2. Components Shown in Figure 1

Item from Figure 1	Description
A	Serial port header (2.0 mm pitch)
B	Front panel header (2.0 mm pitch)
C	Battery
D	Thermal solution
E	Connector for optional processor fan
F	Power LED
G	Custom Solutions header (2.0 mm pitch)
H	VGA header (2.0 mm pitch)

1.1.3 Board Layout (Bottom)

Figure 2 shows the location of the major components on the bottom-side of Intel NUC Board DE3815TYBE.

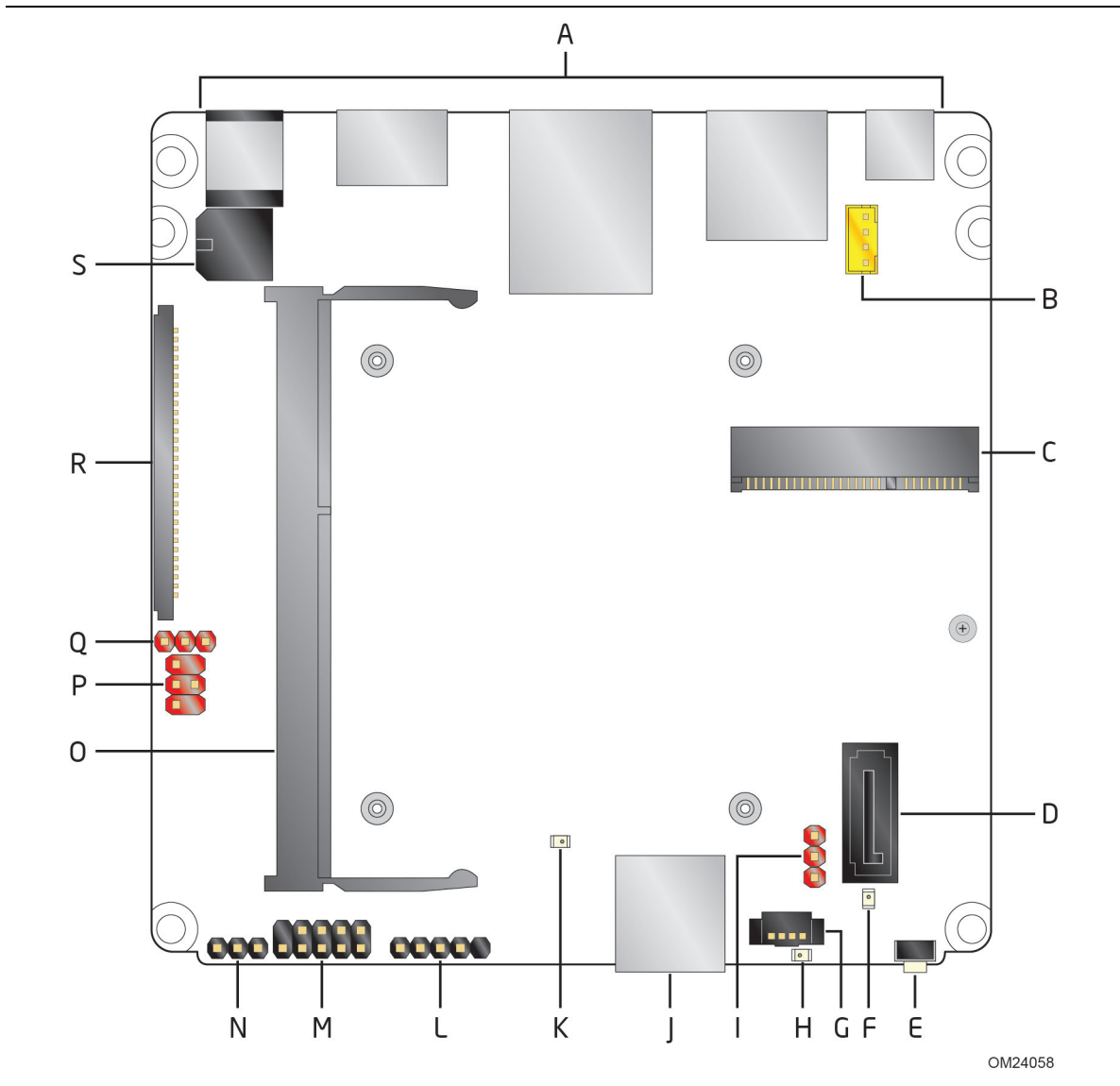

Figure 2. Major Board Components (Bottom)

Table 3. Components Shown in Figure 2

Item from Figure 2	Description
A	Back panel connectors
B	Internal stereo speaker header
C	PCI Express Half-Mini Card connector
D	SATA 3.0 Gb/s connector
E	Illuminated power button
F	Standby power LED
G	SATA power connector
H	Hard Disk Drive (HDD) LED
I	SATA Disk-on-Module (DOM) voltage selection header
J	Front panel USB 3.0 connector
K	USB Hub Suspend LED
L	Front panel single-port USB 2.0 header
M	Front panel dual-port USB 2.0 header
N	BIOS setup configuration jumper
O	DDR3L SO-DIMM 1 socket
P	Flat panel voltage selection header
Q	Backlight inverter voltage selection header
R	eDP connector
S	Molex Micro-Fit 3.0* 2x2 power connector

1.1.4 Block Diagram

Figure 3 is a block diagram of the major functional areas of the board.

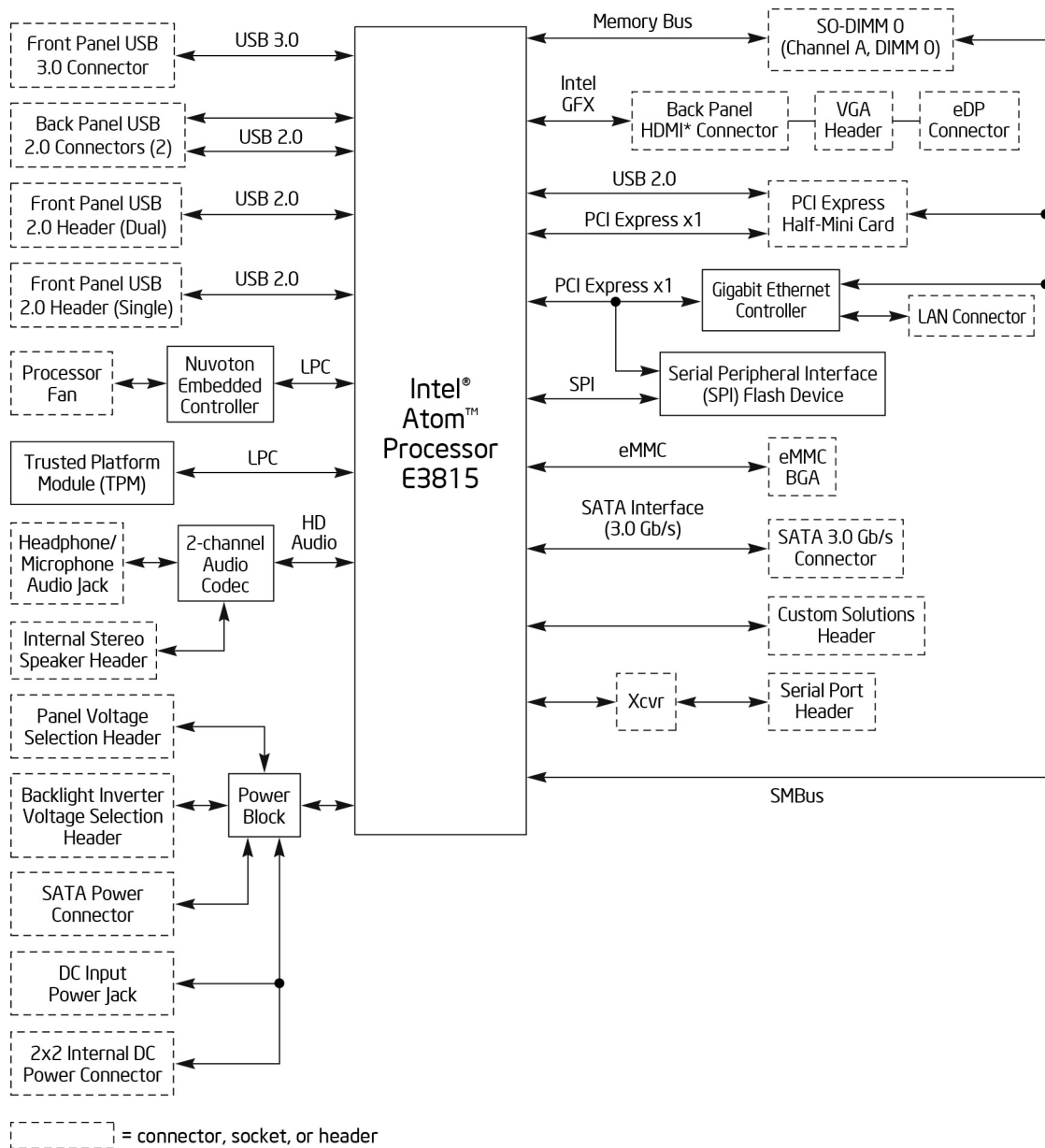

OM24057

Figure 3. Block Diagram

1.2 Online Support

To find information about...

Intel NUC Board DE3815TYBE
NUC Board Support
Available configurations for Intel NUC Board DE3815TYBE
BIOS and driver updates
Tested memory
Integration information

Visit this World Wide Web site:

<http://www.intel.com/NUC>
<http://www.intel.com/NUCSupport>
<http://ark.intel.com>
<http://downloadcenter.intel.com>
<http://www.intel.com/NUCSupport>
<http://www.intel.com/NUCSupport>

1.3 Processor

The board has a soldered-down System-on-a-Chip (SoC), which consists of an Intel Atom processor E3815 with up to ~5 W TDP.

- Integrated graphics
- Integrated memory controller
- Integrated PCH



NOTE

This board has specific requirements for providing power to the processor. Refer to Section 2.5.1 on page 55 for information on power supply requirements for this board.

1.4 System Memory

The board has one 204-pin SO-DIMM socket and supports the following memory features:

- 1.35 V DDR3L 1066 MHz SDRAM SO-DIMM with gold plated contacts
- One memory channel
- Unbuffered, single-sided or double-sided SO-DIMMs
- 8 GB maximum total system memory (with 4 Gb memory technology). Refer to Section 2.1.1 on page 37 for information on the total amount of addressable memory.
- Minimum recommended total system memory: 1024 MB
- Non-ECC SO-DIMMs
- Serial Presence Detect



NOTE

Higher-speed SO-DIMMs will be supported at the 1066 MHz memory timing.



NOTE

To be fully compliant with all applicable DDR SDRAM memory specifications, the board should be populated with SO-DIMMs that support the Serial Presence Detect (SPD) data structure. This allows the BIOS to read the SPD data and program the chipset to accurately configure memory settings for optimum performance. If non-SPD memory is installed, the BIOS will attempt to correctly configure the memory settings, but performance and reliability may be impacted or the SO-DIMMs may not function under the determined frequency.

Table 4 lists the supported SO-DIMM configurations.

Table 4. Supported Memory Configurations

SO-DIMM Capacity	Configuration ^(Note)	SDRAM Density	SDRAM Organization Front-side/Back-side	Number of SDRAM Devices
1024 MB	SS	1 Gbit	128 M x8/empty	8
2048 MB	DS	1 Gbit	128 M x8/128 M x8	16
2048 MB	SS	2 Gbit	256 M x8/empty	8
4096 MB	DS	2 Gbit	256 M x8/256 M x8	16
4096 MB	SS	4 Gbit	512 M x8/empty	8
8192 MB	DS	4 Gbit	512 M x8/512 M x8	16

Note: "DS" refers to double-sided memory modules (containing two rows of SDRAM) and "SS" refers to single-sided memory modules (containing one row of SDRAM).

For information about...

Tested Memory

Refer to:

<http://www.intel.com/NUCSupport>

Figure 4 illustrates the memory channel and SO-DIMM configuration.

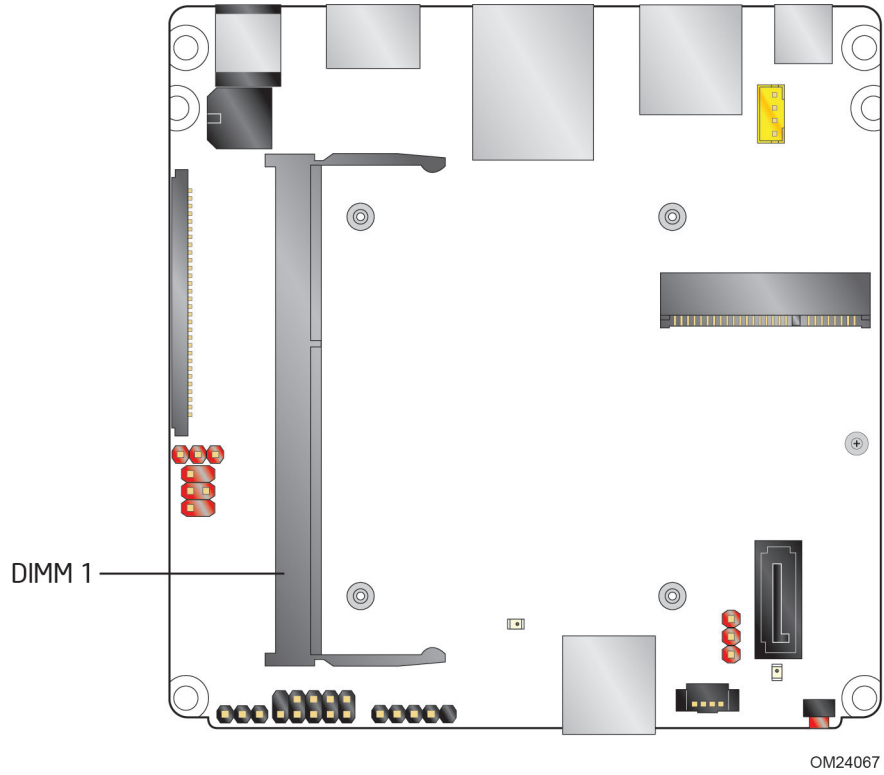

Figure 4. Memory Channel and SO-DIMM Configuration

1.5 Graphics Subsystem

The board supports graphics through Intel Graphics Technology.

1.5.1 Integrated Graphics

The board supports integrated graphics through the Intel® Flexible Display Interface (Intel® FDI) for processors with Intel Graphics Technology.



NOTE

The board can simultaneously support up to two of the three integrated graphics interfaces: VGA, HDMI, and Flat Panel Display.

1.5.1.1 Intel® High Definition (Intel® HD) Graphics

The Intel® GMA graphics controller features the following:

- 640 MHz core frequency
- Video
 - Blu-ray* 2.0
 - PAVP 1.1c
 - HDCP 1.3
- Display
 - Supports VGA displays up to 1920 x 1200 (WUXGA) at 60 Hz
 - Supports HDMI displays up to 1920 x 1200 (WUXGA) at 60 Hz
 - Supports eDP flat panel displays up to 1920 x 1080 at 60 Hz
 - Dual independent display support

For information about

Obtaining graphics software and utilities

Refer to

Section 1.2, page 18

1.5.1.2 Video Memory Allocation

Intel® Dynamic Video Memory Technology (DVMT) is a method for dynamically allocating system memory for use as graphics memory to balance 2D/3D graphics and system performance. If your computer is configured to use DVMT, graphics memory is allocated based on system requirements and application demands (up to the configured maximum amount). When memory is no longer needed by an application, the dynamically allocated portion of memory is returned to the operating system for other uses.

1.5.1.3 High Definition Multimedia Interface* (HDMI*)

The HDMI port supports standard, enhanced, or high definition video, plus multi-channel digital audio on a single cable. The port is compatible with all ATSC and DVB HDTV standards and supports eight full range channels at 24-bit/96 kHz audio of lossless audio formats. The maximum supported resolution is 1920 x 1080 @ 60 Hz, 24 bpp (WUXGA). The HDMI port is compliant with the HDMI 1.4a specification.

1.5.1.3.1 Integrated Audio Provided by the HDMI Interface

The following audio technologies are supported by the HDMI 1.4a interface directly from the SoC:

- AC-3 - Dolby* Digital
- Dolby Digital Plus
- DTS-HD*
- LPCM, 192 kHz/24-bit, 8 Channel

1.5.1.4 Analog Display (VGA)

The VGA port supports analog displays. The maximum supported resolution is 1920 x 1200 (WUXGA) at a 60 Hz refresh rate.

1.5.1.5 Flat Panel Display Interfaces

The board supports flat panel displays via the Embedded DisplayPort interface. Figure 5 shows the flat panel connector.

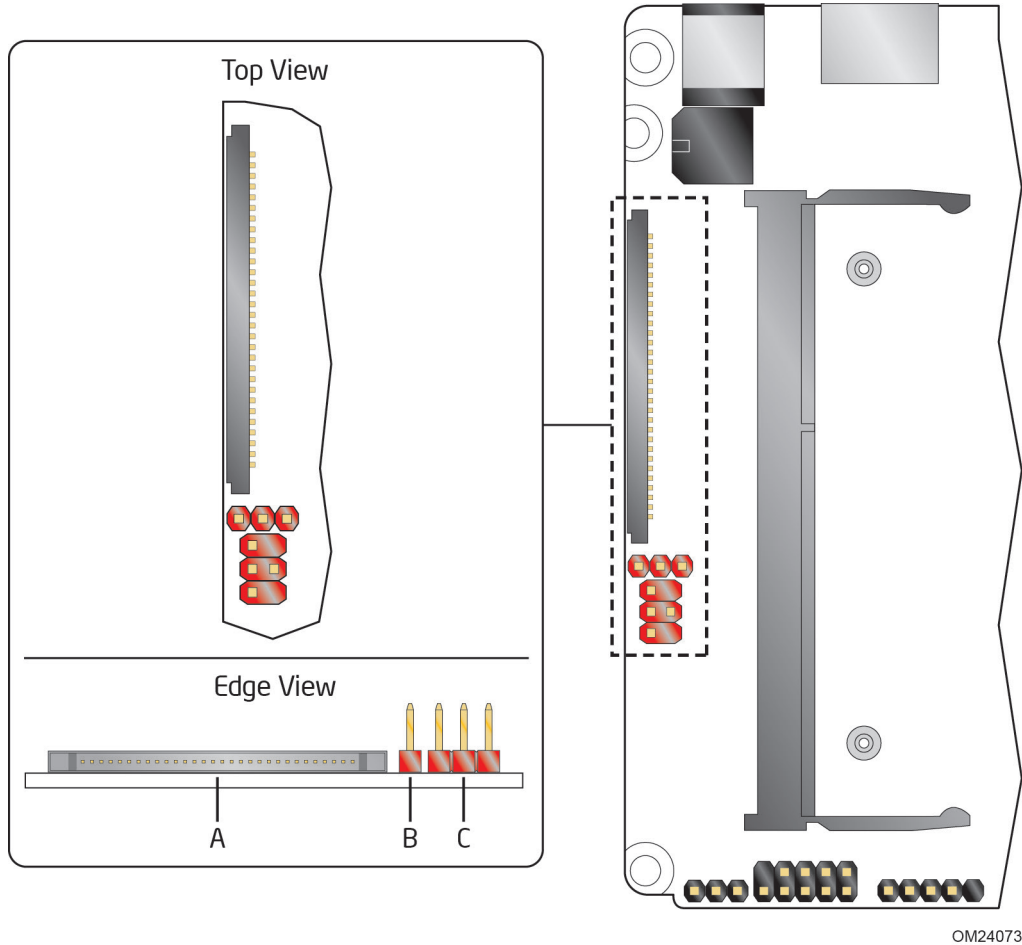

Item	Description
A	Embedded DisplayPort connector
B	Backlight inverter voltage selection header
C	Flat panel voltage selection header

Figure 5. Flat Panel Connectors



NOTE

Backlight inverter voltage option "Vin" refers to board input voltage as provided to board power input connector.

1.5.1.5.1 Embedded DisplayPort* (eDP) Interface

The Embedded DisplayPort (eDP) flat panel display interface supports the following:

- 1920 x 1080 @ 60 Hz resolution
- 1-lane and 2-lane bandwidth at 1.62 Gb/s or 2.7 Gb/s
- Multiple EDID data source capability (panel, predefined, and custom payloads)
- 3.3 V, 5 V, and 12 V flat panel display voltage flexibility, with up to 2 A current
- 5 V, 12 V, and Vin backlight inverter voltage flexibility, with up to 2 A current
- Backlight inverter signal redundancy on a dedicated header as well as on eDP connector (for discrete inverter or panel-integrated inverter support using a single cable)

1.5.1.5.2 Configuration Modes

Video mode configuration for eDP displays is supported as follows:

- Automatic panel identification via Extended Display Identification Data (EDID) for panels with onboard EDID support
- Panel selection from common predefined panel types (without onboard EDID)
- Custom EDID payload installation for ultimate parameter flexibility, allowing custom definition of EDID data on panels without onboard EDID

In addition, BIOS setup provides the following configuration parameters for internal flat panel displays:

- Color Depth: allows the system integrator to select whether the panel is 24 bpp with VESA or JEIDA color mapping, or 18 bpp.
- eDP Interface Type: allows the system integrator to select whether the eDP panel is a 1-lane or 2-lane display.
- eDP Data Rate: allows the system integrator to select whether the eDP panel runs at 1.62 Gb/s or 2.7 Gb/s.
- Inverter Frequency and Polarity: allows the system integrator to set the operating frequency and polarity of the panel inverter board.
- Maximum and Minimum Inverter Current Limit (%): allows the system integrator to set maximum PWM%, as appropriate, according to the power requirements of the internal flat panel display and the selected inverter board.
- Panel Power Sequencing: allows the system integrator to adjust panel power sequencing parameters, if necessary.

**NOTE**

Support for flat panel display configuration complies with the following:

1. Internal flat panel display connectivity is disabled (and all parameters hidden) by default.
2. Internal flat panel display settings are not exposed through Intel® Integrator Toolkit or Intel® Integrator Assistant GUIs.
3. Internal flat panel display settings will not be overwritten by loading BIOS setup defaults.
4. Internal flat panel display settings will be preserved across BIOS updates.
5. Backlight inverter voltage option "Vin" refers to board input voltage as provided to board power input connector.

1.6 USB

The USB port arrangement is as follows:

- One USB 3.0 front panel connector
- Two USB 2.0 back panel connectors
- Two front panel USB 2.0 ports are implemented through a dual-port internal header
- One front panel USB 2.0 port is implemented through a single-port internal header
- One port is reserved for the PCI Express* Half-Mini Card

All the USB ports are high-speed, full-speed, and low-speed capable.

**NOTE**

Computer systems that have an unshielded cable attached to a USB port may not meet FCC Class B requirements, even if no device is attached to the cable. Use a shielded cable that meets the requirements for full-speed devices.

For information about	Refer to
The location of the USB connectors on the back panel	Figure 11, page 38
The location of the USB connector on the front panel	Figure 2, page 15

1.7 SATA Interface

The SoC provides one SATA port with a theoretical maximum transfer rate of 3 Gb/s. A point-to-point interface is used for host to device connections.

The underlying SATA functionality is transparent to the operating system. The SATA controller can operate in both legacy and native modes. In legacy mode, standard IDE I/O and IRQ resources are assigned (IRQ 14 and 15). In Native mode, standard PCI Conventional bus resource steering is used. Native mode is the preferred mode for configurations using Windows operating systems.

1.7.1 SATA Disk-on-Module (DOM) Voltage Selection Header

The board provides support for SATA Disk-on-Module (DOM) via a user-selectable voltage level on SATA data pin 7. See Table 5 for more details.

Table 5. SATA DOM Voltage Selection Header

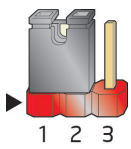
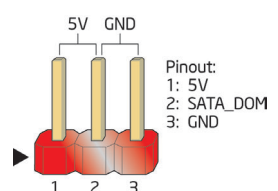
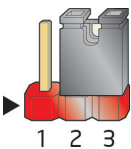
Pins 1 and 2 jumper position for 5 V		
Pins 3 and 2 jumper position for GND (default)		

1.7.2 AHCI Mode

The board supports AHCI storage mode.



NOTE

In order to use AHCI mode, AHCI must be enabled in the BIOS. Microsoft Windows 8 includes the necessary AHCI drivers without the need to install separate AHCI drivers during the operating system installation process. However, it is always good practice to update the AHCI drivers to the latest available by Intel.*

1.8 Real-Time Clock Subsystem

A coin-cell battery (CR2032) powers the real-time clock and CMOS memory. When the computer is not plugged into a wall socket, the battery has an estimated life of three years. When the computer is plugged in, the standby current from the power supply extends the life of the battery. The clock is accurate to ± 13 minutes/year at 25 °C with 3.3 VSB applied via the power supply 5 V STBY rail.



NOTE

If the battery and AC power fail, date and time values will be reset and the user will be notified during the POST.

When the voltage drops below a certain level, the BIOS Setup program settings stored in CMOS RAM (for example, the date and time) might not be accurate. Replace the battery with an equivalent one. Figure 1 on page 13 shows the location of the battery.

1.9 Audio Subsystem

The board supports Intel HD Audio via the Realtek ALC283 audio codec. The audio subsystem supports the following features:

- Analog line-out/Analog Headphone/Analog Microphone (back panel jack)
- High Definition Audio via a stereo microphone/headphone jack on the back panel
- Internal stereo speaker header
- DMIC interface (custom solutions header), with support for mono and stereo digital microphones
- Support for 44.1 kHz/48 kHz/96 kHz/192 kHz sample rates on all analog outputs
- Support for 44.1 kHz/48 kHz/96 kHz sample rates on all analog inputs
- Back Panel Audio Jack Support (see Figure 6 for 3.5 mm audio jack pin out):
 - Speakers only
 - Headphones only
 - Microphone only
 - Combo Headphone/Microphone



Pin Number	Pin Name	Description
1	Tip	Left Audio Out
2	Ring	Right Audio Out
3	Ring	Common/Ground
4	Sleeve	Audio In

Figure 6. 4-Pin 3.5 mm (1/8 inch) Audio Jack Pin Out



NOTE

The analog circuit of the back panel audio connector is designed to power headphones or amplified speakers only. Poor audio quality occurs if passive (nonamplified) speakers are connected to this output.

1.9.1 Audio Subsystem Software

Audio software and drivers are available from Intel's World Wide Web site.

For information about

Obtaining Audio software and drivers

Refer to

<http://downloadcenter.intel.com>

1.10 LAN Subsystem

The LAN subsystem consists of the following:

- Realtek 8111GN-CG Gigabit Ethernet Controller (10/100/1000 Mb/s)
- RJ-45 LAN connector with integrated status LEDs

Additional features of the LAN subsystem include:

- CSMA/CD protocol engine
- Jumbo frame support
- LAN connect interface between the SoC and the LAN controller
- Power management capabilities
 - ACPI technology support
 - LAN wake capabilities
- LAN subsystem software

For information about	Refer to
LAN software and drivers	http://downloadcenter.intel.com

1.10.1 Realtek* 8111GN-CG Gigabit Ethernet Controller

The Realtek 8111GN-CG Gigabit Ethernet Controller supports the following features:

- 10/100/1000 BASE-T IEEE 802.3 compliant
- Energy Efficient Ethernet (EEE) IEEE802.3az support (Low Power Idle (LPI) mode)
- Dual interconnect between the Integrated LAN Controller and the Physical Layer (PHY):
 - PCI Express-based interface for active state operation (S0) state
 - SMBUS for host and management traffic (Sx low power state)
- Compliant to IEEE 802.3x flow control support
- 802.1p and 802.1q
- TCP, IP, and UDP checksum offload (for IPv4 and IPv6)
- Full device driver compatibility

1.10.2 LAN Subsystem Software

LAN software and drivers are available from Intel's World Wide Web site.

For information about	Refer to
Obtaining LAN software and drivers	http://downloadcenter.intel.com

1.10.3 RJ-45 LAN Connector with Integrated LEDs

Two LEDs are built into the RJ-45 LAN connector (shown in Figure 7).

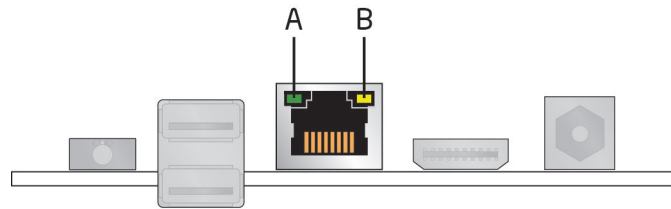

OM24064

Item	Description
A	Link LED (Green)
B	Data Rate LED (Green/Yellow)

Figure 7. LAN Connector LED Locations

Table 6 describes the LED states when the board is powered up and the LAN subsystem is operating.

Table 6. LAN Connector LED States

LED	LED Color	LED State	Condition
Link (A)	Green	Off	LAN link is not established.
		On	LAN link is established.
		Blinking	LAN activity is occurring.
Data Rate (B)	Green/Yellow	Off	10 Mb/s data rate is selected.
		Green	100 Mb/s data rate is selected.
		Yellow	1000 Mb/s data rate is selected.

1.11 Hardware Management Subsystem

The hardware management features enable the board to be compatible with the Wired for Management (WfM) specification. The board has several hardware management features, including thermal and voltage monitoring.

For information about

Wired for Management (WfM) Specification

Refer to

www.intel.com/design/archives/wfm/

1.11.1 Hardware Monitoring

The hardware monitoring and fan control subsystem is based on an ITE IT8607E embedded controller, which supports the following:

- Processor and system ambient temperature monitoring
- Optional processor fan speed monitoring
- Voltage monitoring of +5 V, +3.3 V, Memory Vcc (SDRAM)
- SMBus interface

1.11.2 Fan Monitoring

Fan monitoring can be implemented using third-party software.

1.11.3 Thermal Solution

Figure 8 shows the location of the thermal solution and processor fan header.

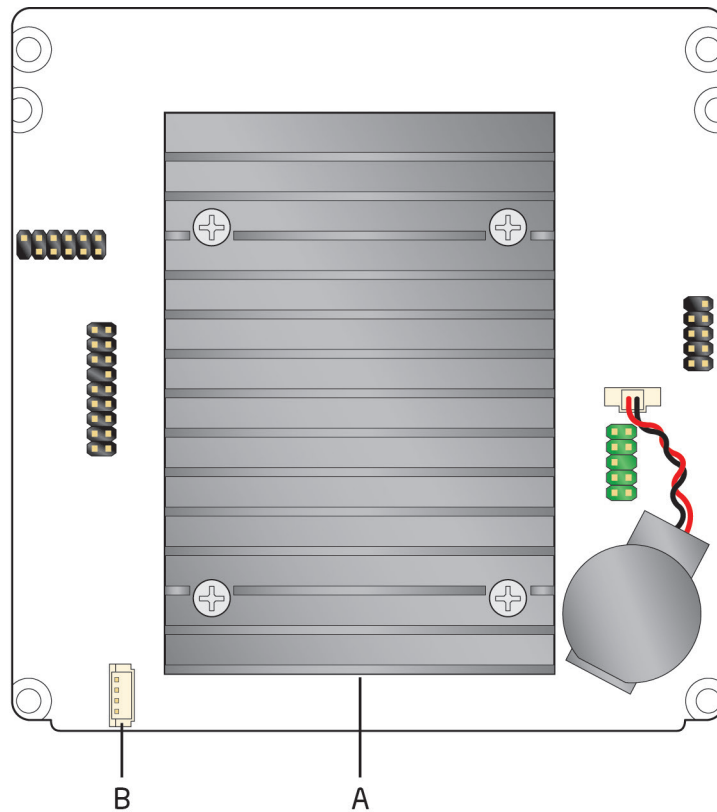

OM24068

Item	Description
A	Thermal solution
B	Processor fan header

Figure 8. Thermal Solution and Fan Header

1.12 Power Management

Power management is implemented at several levels, including:

- Software support through Advanced Configuration and Power Interface (ACPI)
- Hardware support:
 - Power Input
 - Instantly Available PC technology
 - LAN wake capabilities
 - Wake from USB
 - WAKE# signal wake-up support
 - Wake from S5
 - +5 V Standby Power Indicator LED

1.12.1 ACPI

ACPI gives the operating system direct control over the power management and Plug and Play functions of a computer. The use of ACPI with this board requires an operating system that provides full ACPI support. ACPI features include:

- Plug and Play (including bus and device enumeration)
- Power management control of individual devices, add-in boards (some add-in boards may require an ACPI-aware driver), video displays, and disk drives
- Methods for achieving less than 15-watt system operation in the power-on/standby sleeping state
- A Soft-off feature that enables the operating system to power-off the computer
- Support for multiple wake-up events (see Table 9 on page 33)
- Support for a front panel power and sleep mode switch

Table 7 lists the system states based on how long the power switch is pressed, depending on how ACPI is configured with an ACPI-aware operating system.

Table 7. Effects of Pressing the Power Switch

If the system is in this state...	...and the power switch is pressed for	...the system enters this state
Off (ACPI G2/G5 – Soft off)	Less than four seconds	Power-on (ACPI G0 – working state)
On (ACPI G0 – working state)	Less than four seconds	Soft-off/Standby (ACPI G1 – sleeping state) ^{Note}
On (ACPI G0 – working state)	More than six seconds	Fail safe power-off (ACPI G2/G5 – Soft off)
Sleep (ACPI G1 – sleeping state)	Less than four seconds	Wake-up (ACPI G0 – working state)
Sleep (ACPI G1 – sleeping state)	More than six seconds	Power-off (ACPI G2/G5 – Soft off)

Note: Depending on power management settings in the operating system.

1.12.1.1 System States and Power States

Under ACPI, the operating system directs all system and device power state transitions. The operating system puts devices in and out of low-power states based on user preferences and knowledge of how devices are being used by applications. Devices that are not being used can be turned off. The operating system uses information from applications and user settings to put the system as a whole into a low-power state.

Table 8 lists the power states supported by the board along with the associated system power targets. See the ACPI specification for a complete description of the various system and power states.

Table 8. Power States and Targeted System Power

Global States	Sleeping States	Processor States	Device States	Targeted System Power ^(Note 1)
G0 – working state	S0 – working	C0 – working	D0 – working state.	Full power
G1 – sleeping state	S3 – Suspend to RAM. Context saved to RAM.	No power	D3 – no power except for wake-up logic.	Power < 5 W ^(Note 2)
G1 – sleeping state	S4 – Suspend to disk. Context saved to disk.	No power	D3 – no power except for wake-up logic.	Power < 5 W ^(Note 2)
G2/S5	S5 – Soft off. Context not saved. Cold boot is required.	No power	D3 – no power except for wake-up logic.	Power < 5 W ^(Note 2)
G3 – mechanical off AC power is disconnected from the computer.	No power to the system.	No power	D3 – no power for wake-up logic, except when provided by battery or external source.	No power to the system. Service can be performed safely.

Notes:

1. Total system power is dependent on the system configuration, including add-in boards and peripherals powered by the system chassis' power supply.
2. Dependent on the standby power consumption of wake-up devices used in the system.

1.12.1.2 Wake-up Devices and Events

Table 9 lists the devices or specific events that can wake the computer from specific states.

Table 9. Wake-up Devices and Events

Devices/events that wake up the system...	...from this sleep state
Power switch	S3, S4, S5
RTC alarm	S3, S4, S5 ^(Note 1)
LAN	S3, S4, S5 ^(Notes 1, 2)
USB	S3, S4, S5 ^(Note 3, 4)
PCIe via WAKE#	S3, S4, S5 ^(Note 1)

Notes:

1. Monitor will remain in "sleep" state
2. "S5 WoL after G3" supported w/Deep Sleep disabled
3. Wake from S4 and S5 only supported w/Deep Sleep disabled
4. Wake from device/event not supported immediately upon return from AC loss



NOTE

The use of these wake-up events from an ACPI state requires an operating system that provides full ACPI support. In addition, software, drivers, and peripherals must fully support ACPI wake events.

1.12.2 Hardware Support

The board provides several power management hardware features, including:

- Wake from Power Button signal
- Instantly Available PC technology
- LAN wake capabilities
- Wake from USB
- WAKE# signal wake-up support
- Wake from S5
- +5 V Standby Power Indicator LED



NOTE

The use of Wake from USB from an ACPI state requires an operating system that provides full ACPI support.

1.12.2.1 Power Input

When resuming from an AC power failure, the computer may return to the power state it was in before power was interrupted (on or off). The computer's response can be set using the Last Power State feature in the BIOS Setup program's Boot menu.

1.12.2.2 Instantly Available PC Technology

Instantly Available PC technology enables the board to enter the ACPI S3 (Suspend-to-RAM) sleep-state. While in the S3 sleep-state, the computer will appear to be off (the power supply is off, and the front panel LED is amber if dual colored, or off if single colored.) When signaled by a wake-up device or event, the system quickly returns to its last known wake state. Table 9 on page 33 lists the devices and events that can wake the computer from the S3 state.

The use of Instantly Available PC technology requires operating system support and drivers for any installed PCI Express add-in card.

1.12.2.3 LAN Wake Capabilities

LAN wake capabilities enable remote wake-up of the computer through a network. The LAN subsystem monitors network traffic at the Media Independent Interface. Upon detecting a Magic Packet* frame, the LAN subsystem asserts a wake-up signal that powers up the computer.

1.12.2.4 Wake from USB

USB bus activity wakes the computer from an ACPI S3, S4, and S5 states.



NOTE

Wake from USB requires the use of a USB peripheral that supports Wake from USB.

1.12.2.5 WAKE# Signal Wake-up Support

When the WAKE# signal on the PCI Express bus is asserted, the computer wakes from an ACPI S3, S4, or S5 state.

1.12.2.6 Wake from S5

When the RTC Date and Time is set in the BIOS, the computer will automatically wake from an ACPI S5 state.

1.12.2.7 +5 V Standby Power Indicator LED

The standby power indicator LED shows that power is still present even when the computer appears to be off. Figure 9 shows the location of the standby power LED.



CAUTION

If AC power has been switched off and the standby power indicator is still lit, disconnect the power cord before installing or removing any devices connected to the board. Failure to do so could damage the board and any attached devices.

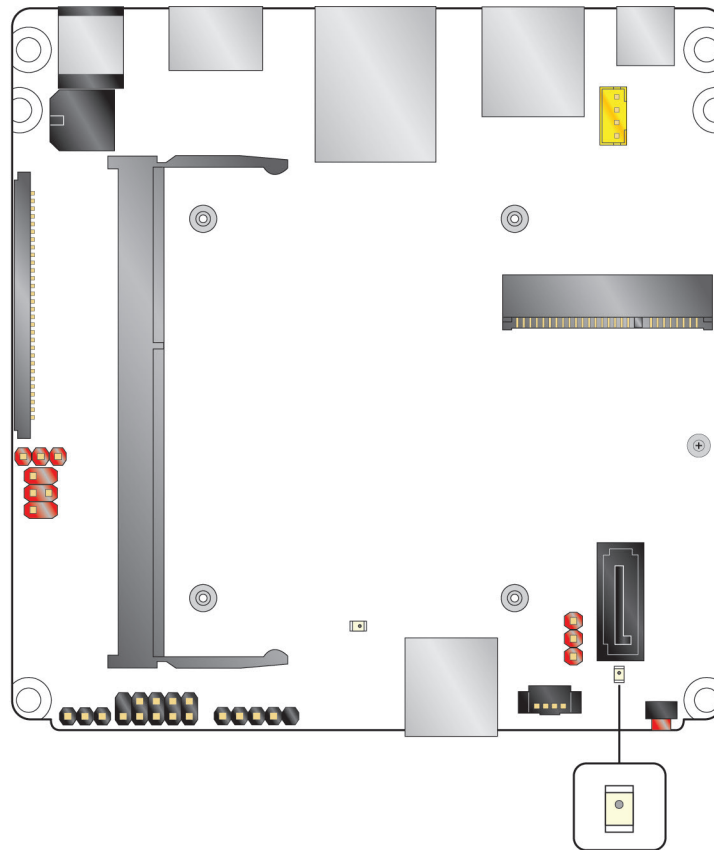

OM24061

Figure 9. Location of the Standby Power LED

1.13 Intel® Security and Manageability Technologies

Intel® Security and Manageability Technologies provides tools and resources to help small business owners and IT organizations protect and manage their assets in a business or institutional environment.



NOTE

Software with security and/or manageability capability is required to take advantage of Intel platform security and/or management technologies.

1.13.1.1 Intel® Virtualization Technology

Intel® Virtualization Technology (Intel® VT) is a hardware-assisted technology that, when combined with software-based virtualization solutions, provides maximum system utilization by consolidating multiple environments into a single server or client.



NOTE

A processor with Intel VT does not guarantee that virtualization will work on your system. Intel VT requires a computer system with a chipset, BIOS, enabling software and/or operating system, device drivers, and applications designed for this feature.

For information about

Intel Virtualization Technology

Refer to

<http://www.intel.com/technology/virtualization/technology.htm>

1.13.1.2 Trusted Platform Module (TPM)

The ST Micro ST33ZP24AR28PVSP version 1.2 revision 116 component is specifically designed to enhance platform security above-and-beyond the capabilities of today's software by providing a protected space for key operations and other security critical tasks. Using both hardware and software, the TPM protects encryption and signature keys at their most vulnerable stages—operations when the keys are being used unencrypted in plain-text form. The TPM shields unencrypted keys and platform authentication information from software-based attacks.

For information about

ST Micro TPM version 1.2

Refer to

<http://www.st.com/web/en/home.html>

2 Technical Reference

2.1 Memory Resources

2.1.1 Addressable Memory

The board utilizes up to 8 GB of addressable system memory. Typically the address space that is allocated for PCI Conventional bus add-in cards, PCI Express configuration space, BIOS (SPI Flash device), and chipset overhead resides above the top of DRAM (total system memory). On a system that has 8 GB of system memory installed, it is not possible to use all of the installed memory due to system address space being allocated for other system critical functions. These functions include the following:

- BIOS/SPI Flash device (64 Mbit)
- Local APIC (19 MB)
- Direct Media Interface (40 MB)
- PCI Express configuration space (256 MB)
- SoC base address registers PCI Express ports (up to 256 MB)
- Memory-mapped I/O (I/O fabric) that is dynamically allocated for PCI Express add-in cards (256 MB)

The board provides the capability to reclaim the physical memory overlapped by the memory mapped I/O logical address space. The board remaps physical memory from the top of usable DRAM boundary to the 4 GB boundary to an equivalent sized logical address range located just above the 4 GB boundary. All installed system memory can be used when there is no overlap of system addresses.

2.2 Connectors and Headers



CAUTION

Only the following connectors and headers have overcurrent protection: back panel and front panel USB.

This section describes the board's connectors and headers. The connectors and headers can be divided into these groups:

- Front panel I/O connector
- Back panel I/O connectors

2.2.1 Front Panel Connector

Figure 10 shows the location of the front panel connector for the board.

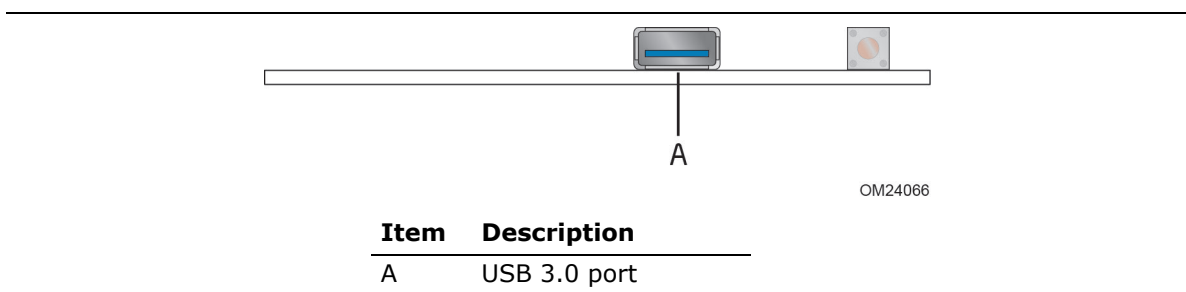

Figure 10. Front Panel Connector

2.2.2 Back Panel Connectors

Figure 11 shows the location of the back panel connectors for the board.

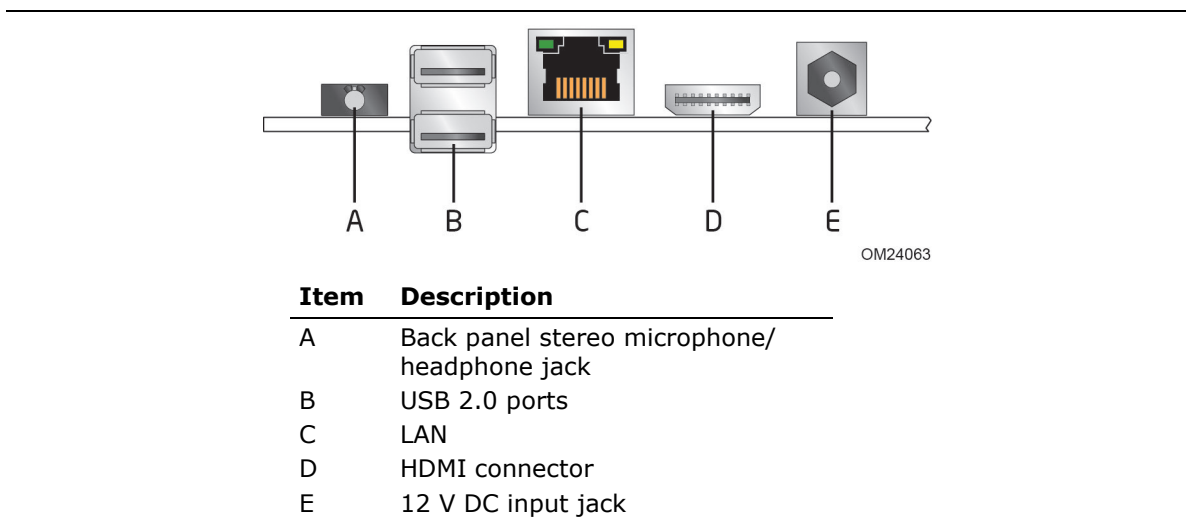
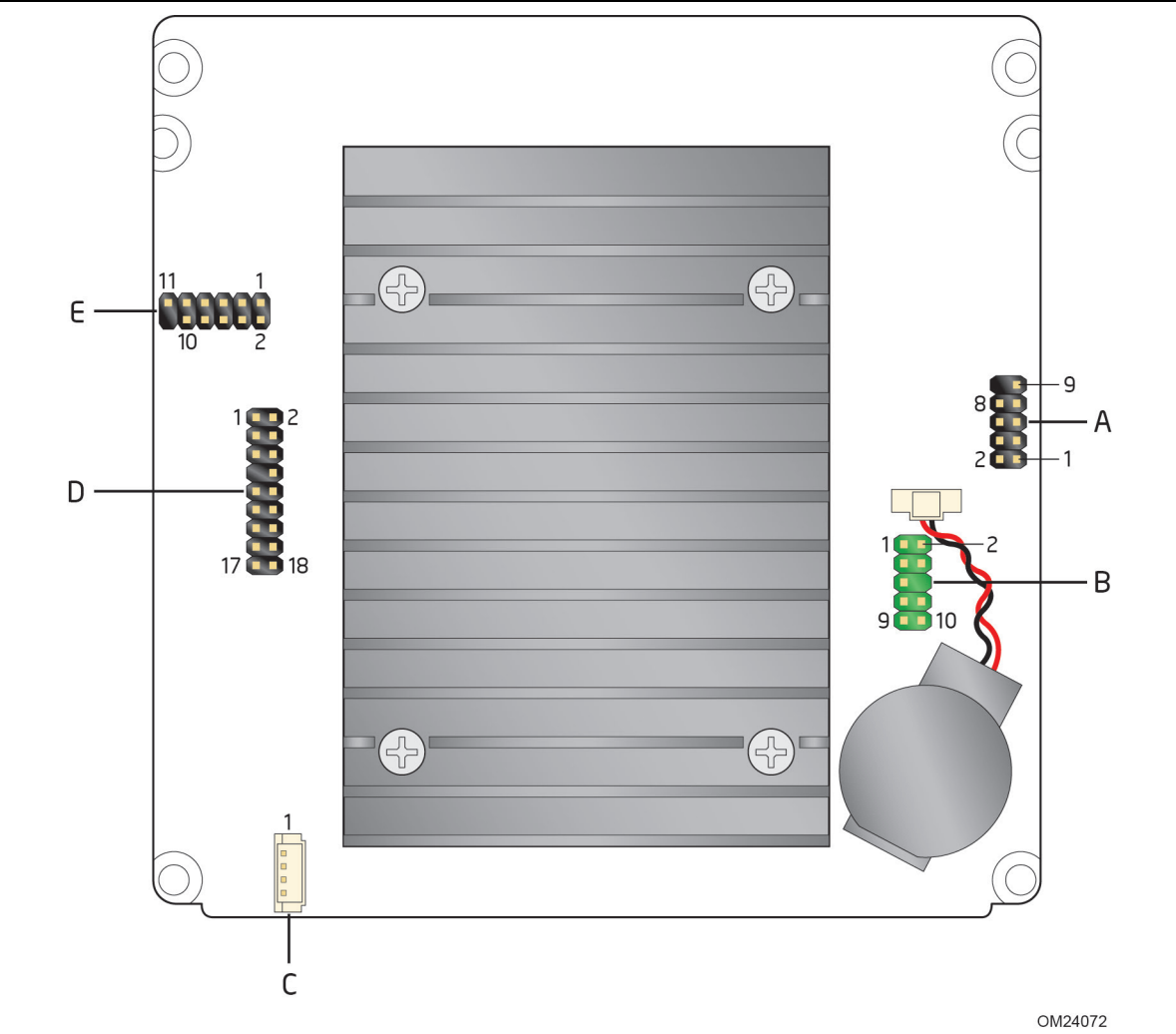

Figure 11. Back Panel Connectors

2.2.3 Headers (Top)

Figure 12 shows the location of the headers on the top-side of the board.



OM24072

Figure 12. Header (Top)

Table 10 lists the header identified in Figure 12.

Table 10. Header Shown in Figure 12

Item from Figure 13	Description
A	Front panel header (2.0 mm pitch)
B	Serial port header (2.0 mm pitch)
C	Connector for optional processor fan
D	Custom Solutions header (2.0 mm pitch)
E	VGA header (2.0 mm pitch)

2.2.4 Connectors and Headers (Bottom)

Figure 13 shows the locations of the connectors and headers on the bottom-side of the board.

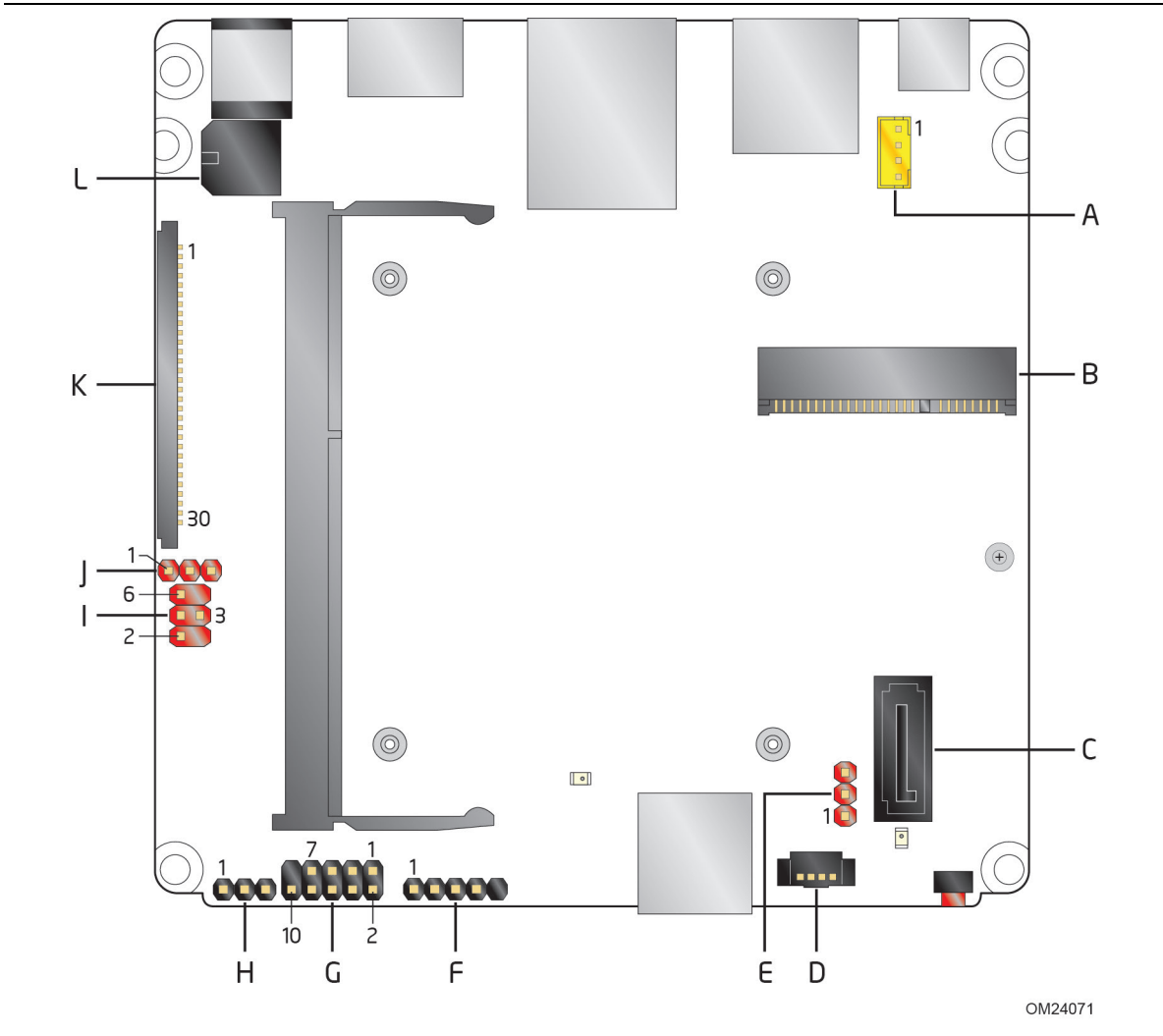

Figure 13. Connectors and Headers (Bottom)

Table 11 lists the connectors and headers identified in Figure 13.

Table 11. Connectors and Headers Shown in Figure 13

Item from Figure 13	Description
A	Internal stereo speaker header
B	PCI Express Half-Mini Card connector
C	SATA 3.0 Gb/s connector
D	SATA power connector
E	SATA DOM voltage selection header
F	Front panel single-port USB 2.0 header
G	Front panel dual-port USB 2.0 header
H	BIOS Security header
I	Flat panel voltage selection header
J	Backlight inverter voltage selection header
K	eDP connector
L	Molex Micro-Fit 3.0 2x2 power connector

2.2.4.1 Signal Tables for the Connectors and Headers

Table 12. PCI Express Half-Mini Card Connector

Pin	Signal Name	Pin	Signal Name
1	WAKE#	2	3.3 V
3	Reserved	4	GND
5	Reserved	6	1.5 V
7	CLKREQ#	8	Reserved
9	GND	10	Reserved
11	REFCLK-	12	Reserved
13	REFCLK+	14	Reserved
15	GND	16	Reserved
17	Reserved	18	GND
19	Reserved	20	Reserved
21	GND	22	PERST#
23	PERn0	24	+3.3 Vaux
25	PERp0	26	GND
27	GND	28	+1.5 V
29	GND	30	SMB_CLK
31	PETn0	32	SMB_DATA
33	PETp0	34	GND
35	GND	36	USB_D-
37	GND	38	USB_D+
39	+3.3 Vaux	40	GND
41	+3.3 Vaux	42	LED_WWAN#
43	Reserved	44	LED_WLAN#
45	Reserved	46	LED_WPAN#
47	Reserved	48	+1.5 V
49	Reserved	50	GND
51	Reserved	52	+3.3 V

Table 13. Internal Stereo Speaker Header

Pin	Signal Name	Description
1	Front_L-	Analog front left (differential negative)
2	Front_L+	Analog front left (differential positive)
3	Front_R+	Analog front right (differential positive)
4	Front_R-	Analog front right (differential negative)

Table 14. Serial Port Header

Pin	Signal Name	Pin	Signal Name
1	SIO_UART1_RXD	2	SIO_UART2_RXD
3	SIO_UART1_TXD	4	SIO_UART2_TXD
5	GND	6	Key (no pin)
7	SIO_UART1_RTS#	8	SIO_UART2_RTS#
9	SIO_UART1_CTS#	10	SIO_UART2_CTS#

Table 15. Front Panel Dual-Port USB 2.0 Header

Pin	Signal Name	Pin	Signal Name
1	+5 V DC	2	+5 V DC
3	D-	4	D-
5	D+	6	D+
7	Ground	8	Ground
9	KEY (no pin)	10	No Connect

Table 16. Front Panel Single-Port USB 2.0 Header

Pin	Signal Name
1	+5 V DC
2	D-
3	D+
4	Ground
5	Key (no pin)

Table 17. Custom Solutions Header

Pin	Signal Name	Pin	Signal Name
1	1.8 Vsby	2	GND
3	HDMI_CEC	4	DMIC_CLK
5	3.3 Vsby	6	DMIC_DATA
7	Key (no pin)	8	SMB_ALERT#
9	5 Vsby (2A)	10	SCI_SMI_GPIO
11	PWM[0]	12	PWM[1]
13	I2C0_CLK	14	I2C0_DATA
15	I2C1_CLK	16	I2C1_DATA
17	SMB_CLK	18	SMB_DATA

Table 18. VGA Header

Pin	Signal Name	Pin	Signal Name
1	CLK	2	DATA
3	VCC	4	VSYNC
5	HSYNC	6	GND
7	RED	8	GND
9	GREEN	10	GND
11	BLUE	12	KEY

Table 19. SATA Connector

Pin	Signal Name
1	Ground
2	TXP
3	TXN
4	Ground
5	RXN
6	RXP
7	Ground

Table 20. SATA Power Connector

Pin	Signal Name
1	5 V DC
2	5 V DC
3	3.3 V DC
4	Ground

Table 21. Flat Panel Voltage Selection Header

Pin	Signal Name	Description
1	Key	No pin
2	3.3 V	3.3 V option
3	12 V	12 V option
4	LCD_VCC	Send voltage to connector
5	Key	No pin
6	5 V	5 V option (default)

Table 22. Backlight Inverter Voltage Selection Header

Pin	Signal Name	Description
1	5 V	5 V option
2	BKLT_PWR	Send voltage to connector
3	Vin	Board input voltage option (default)

Table 23. 30-Pin eDP Connector

Pin	Signal Name	Pin	Signal Name
1	NC_Reserved	16	LCD_GND
2	High-speed_GND	17	HPD (DDPD_HPD)
3	Lane1_N (DDPD_[1]N)	18	BKLT_GND
4	Lane1_P (DDPD_[1]P)	19	BKLT_GND
5	High-speed_GND	20	BKLT_GND
6	Lane0_N (DDPD_[0]N)	21	BKLT_GND
7	Lane0_P (DDPD_[0]P)	22	BKLT_ENABLE
8	High-speed_GND	23	BKLT_PWM_DIM
9	AUX_CH_P (DDPD_AUXP)	24	NC_Reserved
10	AUX_CH_N (DDPD_AUXN)	25	NC_Reserved
11	High-speed_GND	26	BKLT_PWR
12	LCD_VCC	27	BKLT_PWR
13	LCD_VCC	28	BKLT_PWR
14	LCD_Self_Test-or-NC	29	BKLT_PWR
15	LCD_GND	30	NC_Reserved

2.2.4.2 Add-in Card Connector

The board has one PCI Express Half-Mini Card Connector. It will not support mSATA.

2.2.4.3 Front Panel USB Connector and Headers

Figure 14 and Figure 15 are connection diagrams for the front panel USB connector and headers.



NOTE

- The +5 V DC power on the USB headers is fused.
- Use only a front panel USB connector that conforms to the USB 2.0 specification for high-speed USB devices.

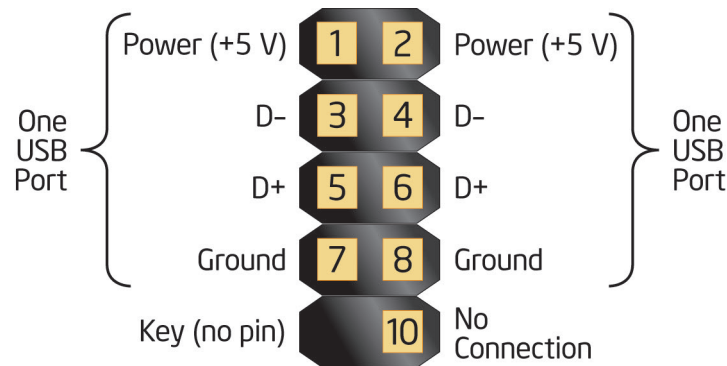

OM20473

Figure 14. Connection Diagram for the Front Panel Dual-Port USB 2.0 Header

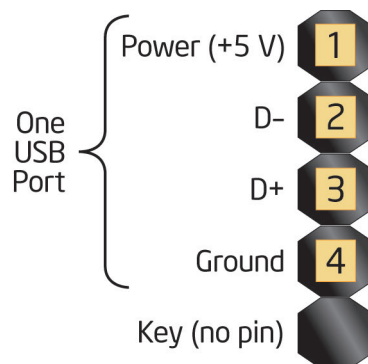

OM23173

Figure 15. Connection Diagram for the Front Panel USB 2.0 Single-Port Header

2.2.4.4 Power Supply Connectors

The board has the following power supply connectors:

- **External Power Supply** – the board can be powered through a 12 V DC connector on the back panel. The back panel DC connector is compatible with a 5.5 mm/OD (outer diameter) and 2.5 mm/ID (inner diameter) plug, where the inner contact is +12 ($\pm 10\%$) V DC through +19 ($\pm 10\%$) V DC and the shell is GND. The maximum current rating is 3 A.
- **Internal Power Supply** – the board can alternatively be powered via the internal Molex Micro-Fit 3.0 2 x 2 power connector, where pins 1 and 2 are +12 ($\pm 10\%$) through +24 ($\pm 10\%$) V DC and pins 3 and 4 are GND. The maximum current rating for this connector is 10 A.

Table 24. Internal Power Supply Connector Pinout

Pin	Signal Name
1, 2	DC input: +12 ($\pm 10\%$) through +24 ($\pm 10\%$) V DC
3, 4	Ground

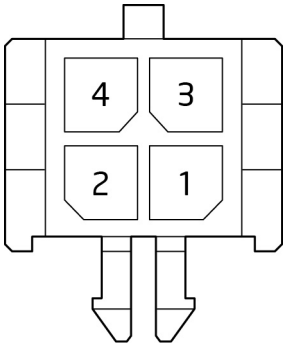

OM24075

Figure 16. Connection Diagram for the Internal Power Supply Connector

For information about	Refer to
Power supply considerations	Section 2.5.1, page 55

2.2.4.5 Front Panel Header

This section describes the functions of the front panel header. Table 25 lists the signal names of the front panel header. Figure 17 is a connection diagram for the front panel header.

Table 25. Front Panel Header

Pin	Signal Name	Description	Pin	Signal Name	Description
1	HDD_POWER_LED	Pull-up resistor (750 Ω) to +5V	2	POWER_LED_MAIN	[Out] Front panel LED (main color)
3	HDD_LED#	[Out] Hard disk activity LED	4	POWER_LED_ALT	[Out] Front panel LED (alt color)
5	GROUND	Ground	6	POWER_SWITCH#	[In] Power switch
7	RESET_SWITCH#	[In] Reset switch	8	GROUND	Ground
9	+5V_DC (1A)	Power	10	Key	No pin

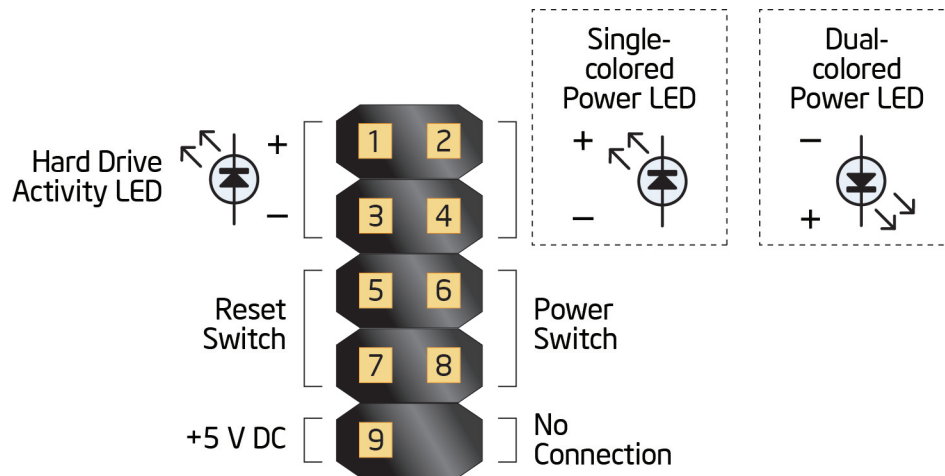

OM24074

Figure 17. Connection Diagram for Front Panel Header

2.2.4.6 Internal Stereo Speaker Header

The internal stereo speaker header allows connection to an internal, low-power speaker for basic system sound capability. The subsystem is capable of driving a speaker load of 8 Ohms at 1 W (rms) or 4 Ohms at 1.5 W (rms).

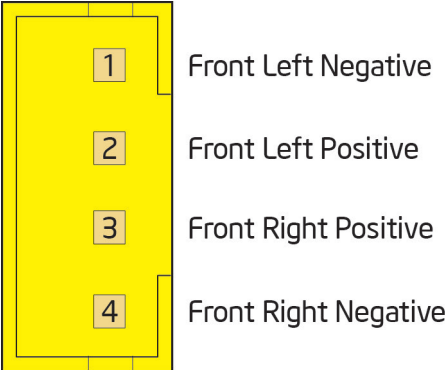

OM24076

Figure 18. Connection Diagram for Stereo Speaker Header

2.2.4.7 Custom Solutions Header (2.0 mm Pitch)

The Custom Solution header is designed to expose access to platform-level signals, enabling custom development of solutions based on such signals.

- 1.8 Vstby, 3.3 Vstby and 5 Vstby: can be used to power custom solution (such as daughtercard, etc.) with up to 2 A of current rating capability per each of these voltages. Pins can also be used to monitor the presence of 1.8 V, 3.3 V and 5 V standby power. Standby power is always on, even when board power is off.
- HDMI Consumer Electronics Control (CEC): standard communication signal from the HDMI connector (<http://www.hdmi.org/>). There is no HDMI CEC controller onboard; rather, the HDMI CEC signal is exposed through this header for third party solutions to monitor/control CEC activity between multiple HDMI devices.
- DMIC_CLK, DMIC_DATA: clock output and data I/O for digital microphone interface; allows connection of a Digital Microphone.
- SCI/SMI GPIO: input signal for direct connection to a signal (such as a front panel push-button) capable of triggering an OS-level command in Windows (formerly referred to by Microsoft as Direct Application Launch*). Voltage level I/O for this pin is 3.3 V. Refer to below URL for accompanying utility to map triggered event to Windows file.
https://downloadcenter.intel.com/Detail_Desc.aspx?lang=eng&DwnldID=22035
- PWM[x]: Pulse-width modulation (PWM) signals that can be used to control analog loads, such as motors or fans. Power rating capability per each PWM signal is 5V at 250mA.
- I2Cx_CLK, I2Cx_DATA: Inter-Integrated Circuit (I²C) bus interface signals that allow connection of low-speed peripherals. Voltage level I/O for these pins is 3.3V. An I²C bus specification and user manual may be found at http://www.nxp.com/documents/user_manual/UM10204.pdf.
- SMB_CLK, SMB_DATA, SMB_ALERT#: System Management Bus (SMBus) interface signals. Voltage level I/O for these pins is 3.3 V. General SMBus information can be found on the platform EDS and at <http://smbus.org/specs/>.

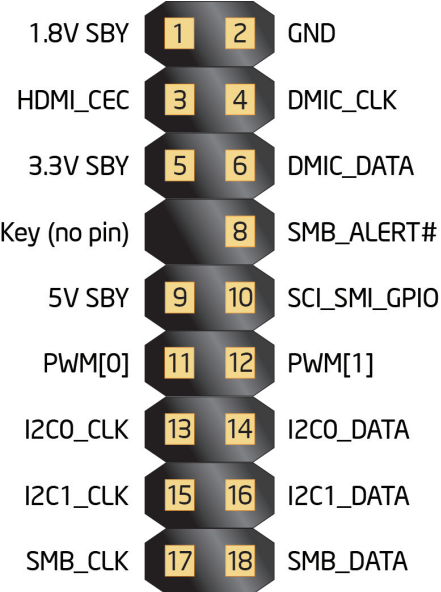

OM24077

Figure 19. Custom Solutions Header

2.3 BIOS Security Jumper



CAUTION

Do not move a jumper with the power on. Always turn off the power and unplug the power cord from the computer before changing a jumper setting. Otherwise, the board could be damaged.

Figure 20 shows the location of the BIOS security jumper. The 3-pin jumper determines the BIOS Security program's mode. Table 26 describes the BIOS security jumper settings for the three modes: normal, lockdown, and configuration.

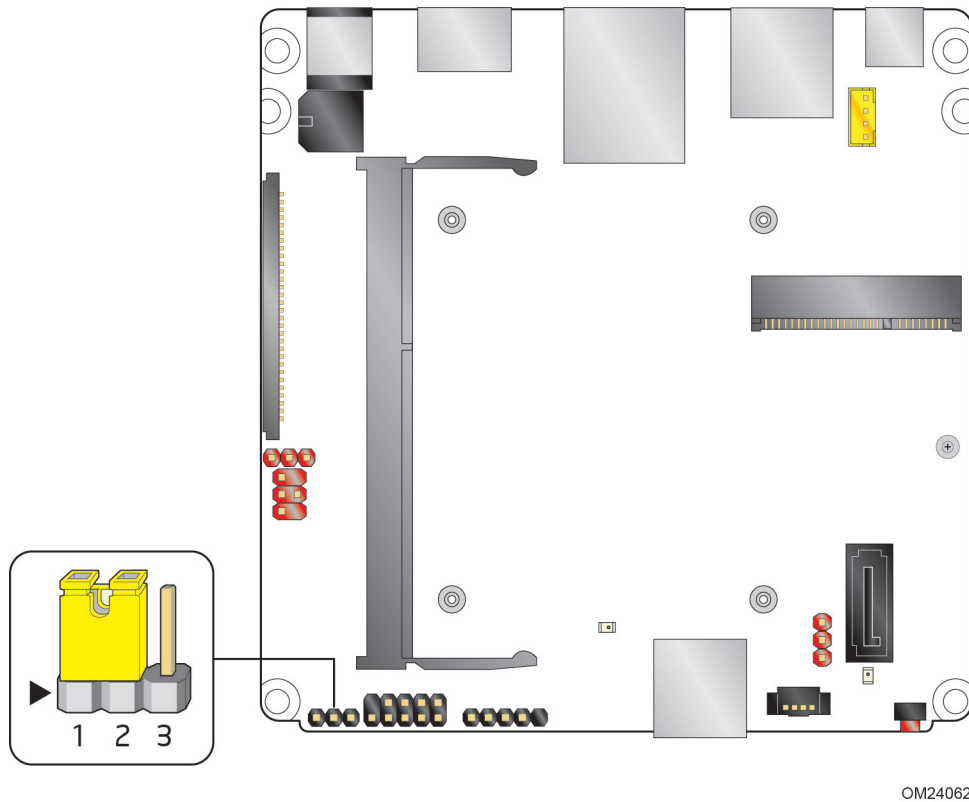

OM24062

Figure 20. Location of the BIOS Security Jumper

Table 26. BIOS Security Jumper Settings

Function/Mode	Jumper Setting	Configuration
Normal	1-2	The BIOS uses current configuration information and passwords for booting.
Lockdown	2-3	<p>The BIOS uses current configuration information and passwords for booting, except:</p> <ul style="list-style-type: none"> • All POST Hotkeys are suppressed (prompts are not displayed and keys are not accepted. For example, F2 for Setup, F10 for the Boot Menu). • Power Button Menu is not available (see Section 3.7.4 Power Button Menu). <p>BIOS updates are not available except for automatic Recovery due to flash corruption.</p>
Configuration	None	<p>BIOS Recovery Update process if a matching *.bio file is found. Recovery Update can be cancelled by pressing the Esc key.</p> <p>If the Recovery Update was cancelled or a matching *.bio file was not found, a Config Menu will be displayed. The Config Menu consists of the following:</p> <p>[1] Suppress this menu until the BIOS Security Jumper is replaced.</p> <p>[2] Clear BIOS User and Supervisor Passwords.</p> <p>[3] Clear Trusted Platform Module</p> <p>Warning: Data encrypted with the TPM will no longer be accessible if the TPM is cleared.</p>

2.4 Mechanical Considerations

2.4.1 Form Factor

The board is designed to fit into a custom chassis. Figure 21 illustrates the mechanical form factor for the board. Dimensions are given in millimeters. The outer dimensions are 101.60 millimeters by 101.60 millimeters [4.0 inches by 4.0 inches].

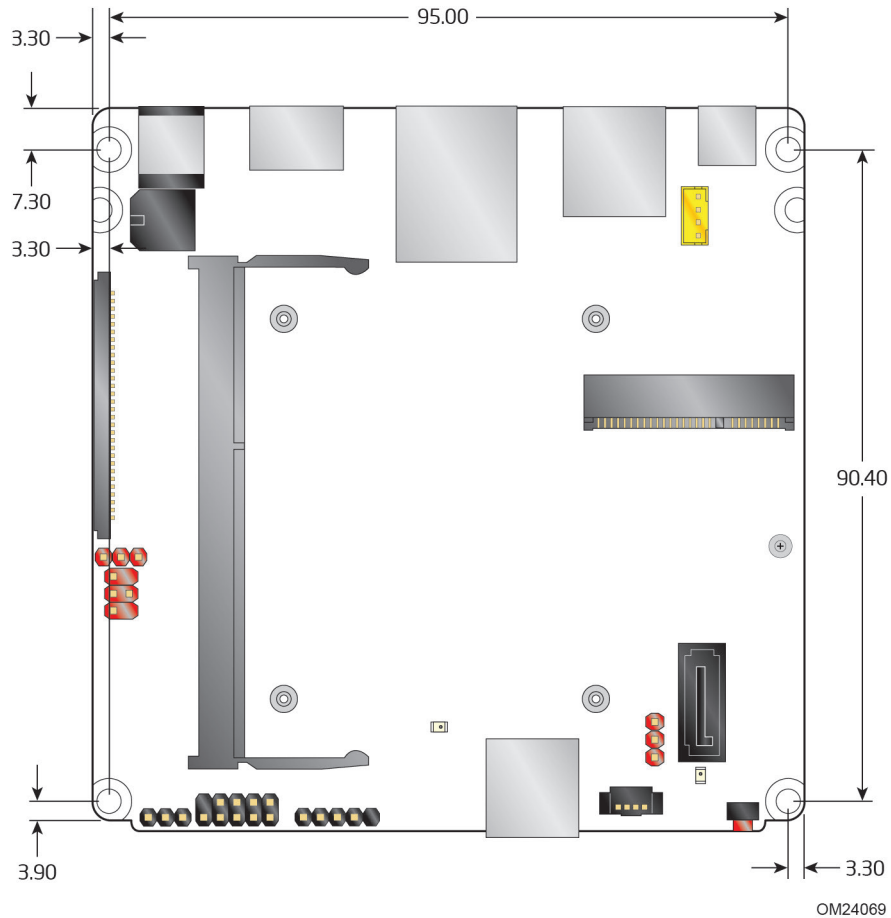

Figure 21. Board Dimensions

2.5 Electrical Considerations

2.5.1 Power Supply Considerations

System power requirements will depend on actual system configurations chosen by the integrator, as well as end user expansion preferences. It is the system integrator’s responsibility to ensure an appropriate power budget for the system configuration is properly assessed based on the system-level components chosen.

Table 27. Power Budget for Assessing the DC-to-DC Circuit’s Power Rating (worst case: Embedded board in 3rd party chassis)

DE3815TYBE (3 rd party chassis)	Max Power Rating (W)	Power Req ¹ (W)	Util	Budget
5 W SoC	5	5.9	85%	5.0
8 GB DDR3L ²	5	5.9	95%	5.6
4 GB eMMC	0.72	0.8	95%	0.8
1 x USB3 (std 900mA) ³	4.5	5.3	100%	5.3
2 x USB2 (std 500mA) ⁴	5	5.9	100%	5.9
3 x USB2 (std 500mA) ⁴	7.5	8.8	100%	8.8
PCIe* HMC ⁵	5	5.9	23%	1.4
SATA power ⁶	5.0	5.9	100%	5.9
LAN, video, audio, other	2.9	3.4	95%	3.2
Custom Solutions	12.55	14.8	100%	14.8
eDP LCD w/LED backlight	20	25.0	95%	23.8
Total System Power				80.4

Notes:

1. Power requirements estimated at 85% efficiency (combined AC adapter + DC-to-DC/VR).
2. 8 GB power consumption estimation: $(1.35V \times 0.230A) \times 16 = 4.968$ W.
3. 100% utilization for USB3 refers to current draw of 900mA (out of 900mA max).
4. 100% utilization for USB2 refers to current draw of 500mA on all ports (500mA/port max).
5. 23% utilization for Half-Mini Card refers to estimation of 1.15 W power consumption of typical 802.11bgn mini-card.
6. 100% utilization for SATA refers to 1A (5 W)) 2.5" HDD power consumption.

2.5.2 Fan Header Current Capability

Table 28 lists the current capability of the fan header.

Table 28. Fan Header Current Capability

Fan Header	Maximum Available Current
Processor fan	.25 A

2.6 Thermal Considerations



CAUTION

A chassis with a maximum internal ambient temperature of 50 °C at the processor fan inlet is a requirement. Whenever possible, use of a processor heat sink that provides omni-directional airflow to maintain required airflow across the processor voltage regulator area is recommended.



CAUTION

Failure to ensure appropriate airflow may result in reduced performance of both the processor and/or voltage regulator or, in some instances, damage to the board.

All responsibility for determining the adequacy of any thermal or system design remains solely with the system integrator. Intel makes no warranties or representations that merely following the instructions presented in this document will result in a system with adequate thermal performance.



CAUTION

Ensure that the ambient temperature does not exceed the board's maximum operating temperature. Failure to do so could cause components to exceed their maximum case temperature and malfunction. For information about the maximum operating temperature, see the environmental specifications in Section 2.8.



CAUTION

The processor voltage regulator area (shown in Figure 22) can reach a temperature of up to 97.5 °C in an open chassis. Ensure that proper airflow is maintained in the processor voltage regulator circuit. Failure to do so may result in shorter than expected product lifetime.

Figure 22 shows the locations of the localized high temperature zones.

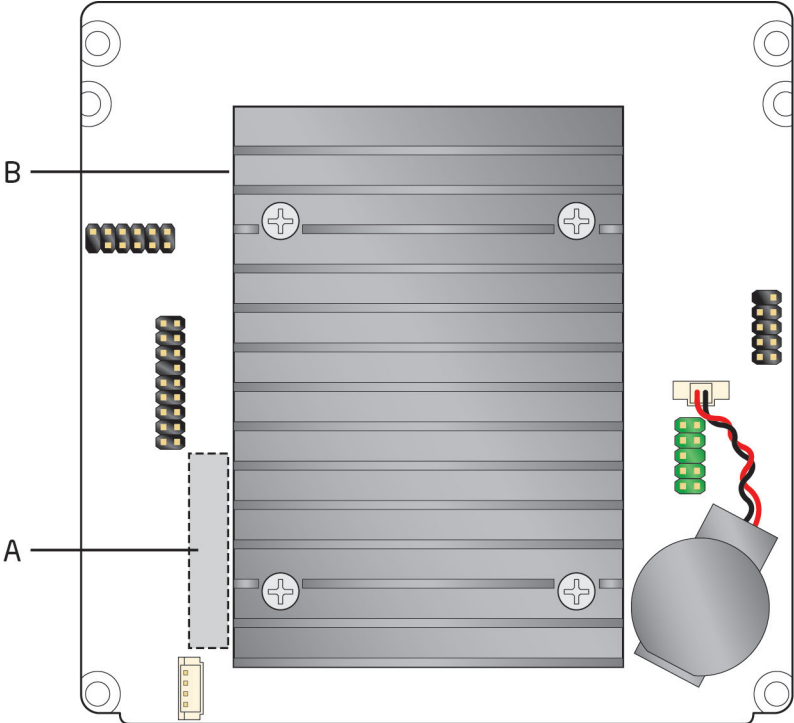

OM24070

Item	Description
A	Processor voltage regulator area
B	Thermal solution

Figure 22. Localized High Temperature Zones

Table 29 provides maximum case temperatures for the components that are sensitive to thermal changes. The operating temperature, current load, or operating frequency could affect case temperatures. Maximum case temperatures are important when considering proper airflow to cool the board.

Table 29. Thermal Considerations for Components

Component	Maximum Case Temperature
Processor	For processor case temperature, see processor datasheets and processor specification updates

To ensure functionality and reliability, the component is specified for proper operation when Case Temperature is maintained at or below the maximum temperature listed in Table 30. This is a requirement for sustained power dissipation equal to Thermal Design Power (TDP is specified as the maximum sustainable power to be dissipated by the components). When the component is dissipating less than TDP, the case temperature should be below the Maximum Case Temperature. The surface temperature at the geometric center of the component corresponds to Case Temperature.

It is important to note that the temperature measurement in the system BIOS is a value reported by embedded thermal sensors in the components and does not directly correspond to the Maximum Case Temperature. The upper operating limit when monitoring this thermal sensor is Tcontrol.

Table 30. Tcontrol Values for Components

Component	Tcontrol
Processor	For processor case temperature, see processor datasheets and processor specification updates

For information about	Refer to
Processor datasheets and specification updates	Section 1.2, page 18

2.7 Reliability

The Mean Time Between Failures (MTBF) prediction is calculated using component and subassembly random failure rates. The calculation is based on the Telcordia SR-332-2 Issue 2, Method I, Case 3, 55 °C ambient. The MTBF prediction is used to estimate repair rates and spare parts requirements. The MTBF for the board is 68,690 hours.

2.8 Environmental

Table 31 lists the environmental specifications for the board.

Table 31. Environmental Specifications

Parameter	Specification		
Temperature			
Non-Operating	-40 °C to +60 °C		
Operating	0 °C to +50 °C		
Shock			
Unpackaged	50 g trapezoidal waveform		
	Velocity change of 170 inches/s ²		
Packaged	Half sine 2 millisecond		
	Product Weight (pounds)	Free Fall (inches)	Velocity Change (inches/s ²)
	<20	36	167
	21-40	30	152
	41-80	24	136
	81-100	18	118
Vibration			
Unpackaged	5 Hz to 20 Hz: 0.01 g ² Hz sloping up to 0.02 g ² Hz		
	20 Hz to 500 Hz: 0.02 g ² Hz (flat)		
Packaged	5 Hz to 40 Hz: 0.015 g ² Hz (flat)		
	40 Hz to 500 Hz: 0.015 g ² Hz sloping down to 0.00015 g ² Hz		



NOTE

Before attempting to operate this board, the overall temperature of the board must be above the minimum operating temperature specified. It is recommended that the board temperature be at least room temperature before attempting to power on the board. The operating and non-operating environment must avoid condensing humidity.

3 Overview of BIOS Features

3.1 Introduction

The board uses an Intel Visual BIOS that is stored in the Serial Peripheral Interface Flash Memory (SPI Flash) and can be updated using a disk-based program. The SPI Flash contains the Visual BIOS Setup program, POST, the PCI auto-configuration utility, LAN EEPROM information, and Plug and Play support. The initial production BIOSs are identified as TYBYT10H.86A.

The Visual BIOS Setup program can be used to view and change the BIOS settings for the computer, and to update the system BIOS. The BIOS Setup program is accessed by pressing the <F2> key after the Power-On Self-Test (POST) memory test begins and before the operating system boot begins.



NOTE

The maintenance menu is displayed only when the board is in configuration mode. Section 2.3 on page 52 shows how to put the board in configuration mode.

3.2 BIOS Flash Memory Organization

The Serial Peripheral Interface Flash Memory (SPI Flash) includes a 64 Mb (8192 KB) flash memory device.

3.3 System Management BIOS (SMBIOS)

SMBIOS is a Desktop Management Interface (DMI) compliant method for managing computers in a managed network.

The main component of SMBIOS is the Management Information Format (MIF) database, which contains information about the computing system and its components. Using SMBIOS, a system administrator can obtain the system types, capabilities, operational status, and installation dates for system components. The MIF database defines the data and provides the method for accessing this information. The BIOS enables applications such as third-party management software to use SMBIOS. The BIOS stores and reports the following SMBIOS information:

- BIOS data, such as the BIOS revision level
- Fixed-system data, such as peripherals, serial numbers, and asset tags
- Resource data, such as memory size, cache size, and processor speed
- Dynamic data, such as event detection and error logging

Non-Plug and Play operating systems require an additional interface for obtaining the SMBIOS information. The BIOS supports an SMBIOS table interface for such operating

systems. Using this support, an SMBIOS service-level application running on a non-Plug and Play operating system can obtain the SMBIOS information. Additional board information can be found in the BIOS under the Additional Information header under the Main BIOS page.

3.4 Legacy USB Support

Legacy USB support enables USB devices to be used even when the operating system's USB drivers are not yet available. Legacy USB support is used to access the BIOS Setup program, and to install an operating system that supports USB. By default, Legacy USB support is set to Enabled.

Legacy USB support operates as follows:

1. When you apply power to the computer, legacy support is disabled.
2. POST begins.
3. Legacy USB support is enabled by the BIOS allowing you to use a USB keyboard to enter and configure the BIOS Setup program and the maintenance menu.
4. POST completes.
5. The operating system loads. While the operating system is loading, USB keyboards and mice are recognized and may be used to configure the operating system. (Keyboards and mice are not recognized during this period if Legacy USB support was set to Disabled in the BIOS Setup program.)
6. After the operating system loads the USB drivers, all legacy and non-legacy USB devices are recognized by the operating system, and Legacy USB support from the BIOS is no longer used.
7. Additional USB legacy feature options can be access by using Intel® Integrator Toolkit.

To install an operating system that supports USB, verify that Legacy USB support in the BIOS Setup program is set to Enabled and follow the operating system's installation instructions.

3.5 BIOS Updates

The BIOS can be updated using either of the following utilities, which are available on the Intel World Wide Web site:

- Intel® Express BIOS Update utility, which enables automated updating while in the Windows environment. Using this utility, the BIOS can be updated from a file on a hard disk, a USB drive (a flash drive or a USB hard drive), or a CD-ROM, or from the file location on the Web.
- Intel® Flash Memory Update Utility, which requires booting from DOS. Using this utility, the BIOS can be updated from a file on a hard disk, a USB drive (a flash drive or a USB hard drive), or a CD-ROM.

- Intel F7 switch during POST allows a user to select where the BIOS .bio file is located and perform the update from that location/device. Similar to performing a BIOS Recovery without removing the BIOS configuration jumper.
- Intel Visual BIOS allows the user to select the BIOS .bio file from the internet, USB device, hard disk drive, or other media.

All utilities verify that the updated BIOS matches the target system to prevent accidentally installing an incompatible BIOS.



NOTE

Review the instructions distributed with the upgrade utility before attempting a BIOS update.

For information about	Refer to
BIOS update utilities	http://www.intel.com/support/motherboards/desktop/sb/CS-034499.htm

3.5.1 Language Support

The BIOS Setup program and help messages are supported in US English. Check the Intel web site for support.

3.5.2 Custom Splash Screen

During POST, an Intel® splash screen is displayed by default. This splash screen can be augmented with a custom splash screen. The Intel Integrator’s Toolkit that is available from Intel can be used to create a custom splash screen.



NOTE

If you add a custom splash screen, it will share space with the Intel branded logo.

For information about	Refer to
Intel Integrator Toolkit	http://developer.intel.com/design/motherbd/software/itk/
Additional Intel® software tools	http://developer.intel.com/design/motherbd/software.htm

3.6 BIOS Recovery

It is unlikely that anything will interrupt a BIOS update; however, if an interruption occurs, the BIOS could be damaged. Table 32 lists the drives and media types that can and cannot be used for BIOS recovery. The BIOS recovery media does not need to be made bootable.

Table 32. Acceptable Drives/Media Types for BIOS Recovery

Media Type ^(Note)	Can be used for BIOS recovery?
Hard disk drive (connected to SATA or USB)	Yes
CD/DVD drive (connected to SATA or USB)	Yes
USB flash drive	Yes
USB diskette drive (with a 1.4 MB diskette)	No (BIOS update file is bigger than 1.4 MB size limit)



NOTE

Supported file systems for BIOS recovery:

- *NTFS (sparse, compressed, or encrypted files are not supported)*
- *FAT32*
- *FAT16*
- *FAT12*
- *ISO 9660*

For information about

Refer to

BIOS recovery

<http://www.intel.com/support/motherboards/desktop/sb/CS-034524.htm>

3.7 Boot Options

In the BIOS Setup program, the user can choose to boot from a hard drive, removable drive, or the network. The default setting is for the hard drive to be the first boot device, the removable drive second, and the network third.

3.7.1 Network Boot

The network can be selected as a boot device. This selection allows booting from the onboard LAN or a network add-in card with a remote boot ROM installed.

Pressing the <F12> key during POST automatically forces booting from the LAN. To use this key during POST, the User Access Level in the BIOS Setup program's Security menu must be set to Full.

3.7.2 Booting Without Attached Devices

For use in embedded applications, the BIOS has been designed so that after passing the POST, the operating system loader is invoked even if the following devices are not present:

- Video adapter
- Keyboard
- Mouse

3.7.3 Changing the Default Boot Device During POST

Pressing the <F10> key during POST causes a boot device menu to be displayed. This menu displays the list of available boot devices. Table 33 lists the boot device menu options.

Table 33. Boot Device Menu Options

Boot Device Menu Function Keys	Description
<↑> or <↓>	Selects a default boot device
<Enter>	Exits the menu, and boots from the selected device
<Esc>	Exits the menu and boots according to the boot priority defined through BIOS setup

3.7.4 Power Button Menu

The Power Button Menu is accessible via the following sequence:

1. System is in S4/S5 (not G3)
2. User pushes the power button and holds it down
3. The system will emit three short beeps from the PC speaker, if equipped, then stop to signal the user to release the power button (approximately 3 seconds)
4. User releases the power button before the 4-second shutdown override

If this boot path is taken, the BIOS will use default settings, ignoring settings in VPD where possible.

At the point where Setup Entry/Boot would be in the normal boot path, the BIOS will display the following prompt and wait for a keystroke:

[ESC] Normal Boot
[F2] Intel Visual BIOS
[F3] Disable Fast Boot
[F4] BIOS Recovery
[F7] Update BIOS
[F10] Enter Boot Menu
[F12] Network Boot

[F3] Disable Fast Boot is only displayed if at least one Fast Boot optimization is enabled.

If an unrecognized key is hit, then the BIOS will beep and wait for another keystroke. If one of the listed hotkeys is hit, the BIOS will follow the indicated boot path. Password requirements must still be honored.

If Disable Fast Boot is selected, the BIOS will disable all Fast Boot optimizations and reset the system.



NOTE

Any beep sounds emitted by the BIOS will be routed to the internal speaker header.

3.8 Hard Disk Drive Password Security Feature

The Hard Disk Drive Password Security feature blocks read and write accesses to the hard disk drive until the correct password is given. Hard Disk Drive Passwords are set in BIOS SETUP and are prompted for during BIOS POST. For convenient support of S3 resume, the system BIOS will automatically unlock drives on resume from S3. Valid password characters are A-Z, a-z, and 0-9. Passwords may be up to 16 characters in length.

The User hard disk drive password, when installed, will be required upon each power-cycle until the Master Key or User hard disk drive password is submitted.

The Master Key hard disk drive password, when installed, will not lock the drive. The Master Key hard disk drive password exists as an unlock override in the event that the User hard disk drive password is forgotten. Only the installation of the User hard disk drive password will cause a hard disk to be locked upon a system power-cycle.

Table 34 shows the effects of setting the Hard Disk Drive Passwords.

Table 34. Master Key and User Hard Drive Password Functions

Password Set	Password During Boot
Neither	None
Master only	None
User only	User only
Master and User Set	Master or User

During every POST, if a User hard disk drive password is set, POST execution will pause with the following prompt to force the user to enter the Master Key or User hard disk drive password:

```
Enter Hard Disk Drive Password:
```

Upon successful entry of the Master Key or User hard disk drive password, the system will continue with normal POST.

If the hard disk drive password is not correctly entered, the system will go back to the above prompt. The user will have three attempts to correctly enter the hard disk drive password. After the third unsuccessful hard disk drive password attempt, the system will halt with the message:

```
Hard Disk Drive Password Entry Error
```

A manual power cycle will be required to resume system operation.



NOTE

The passwords are stored on the hard disk drive so if the drive is relocated to another computer that does not support Hard Disk Drive Password Security feature, the drive will not be accessible.

3.9 BIOS Security Features

The BIOS includes security features that restrict access to the BIOS Setup program and who can boot the computer. A supervisor password and a user password can be set for the BIOS Setup program and for booting the computer, with the following restrictions:

- The supervisor password gives unrestricted access to view and change all the Setup options in the BIOS Setup program. This is the supervisor mode.
- The user password gives restricted access to view and change Setup options in the BIOS Setup program. This is the user mode.
- If only the supervisor password is set, pressing the <Enter> key at the password prompt of the BIOS Setup program allows the user restricted access to Setup.
- If both the supervisor and user passwords are set, users can enter either the supervisor password or the user password to access Setup. Users have access to Setup respective to which password is entered.
- Setting the user password restricts who can boot the computer. The password prompt will be displayed before the computer is booted. If only the supervisor password is set, the computer boots without asking for a password. If both passwords are set, the user can enter either password to boot the computer.
- For enhanced security, use different passwords for the supervisor and user passwords.
- Valid password characters are A-Z, a-z, and 0-9. Passwords may be up to 16 characters in length.
- To clear a set password, enter a blank password after entering the existing password.

Table 35 shows the effects of setting the supervisor password and user password. This table is for reference only and is not displayed on the screen.

Table 35. Supervisor and User Password Functions

Password Set	Supervisor Mode	User Mode	Setup Options	Password to Enter Setup	Password During Boot
Neither	Can change all options (Note)	Can change all options (Note)	None	None	None
Supervisor only	Can change all options	Can change a limited number of options	Supervisor Password	Supervisor	None
User only	N/A	Can change all options	Enter Password Clear User Password	User	User
Supervisor and user set	Can change all options	Can change a limited number of options	Supervisor Password Enter Password	Supervisor or user	Supervisor or user

Note: If no password is set, any user can change all Setup options.

4 Error Messages and Blink Codes

4.1 Front-panel Power LED Blink Codes

Whenever a recoverable error occurs during POST, the BIOS causes the board's front panel power LED to blink an error message describing the problem (see Table 36).

Table 36. Front-panel Power LED Blink Codes

Type	Pattern	Note
BIOS update in progress	Off when the update begins, then on for 0.5 seconds, then off for 0.5 seconds. The pattern repeats until the BIOS update is complete.	
Video error ^(Note)	On-off (1.0 second each) two times, then 2.5-second pause (off), entire pattern repeats (blink and pause) until the system is powered off.	When no VGA option ROM is found.
Memory error	On-off (1.0 second each) three times, then 2.5-second pause (off), entire pattern repeats (blinks and pause) until the system is powered off.	
Thermal trip warning	Each beep will be accompanied by the following blink pattern: .25 seconds on, .25 seconds off, .25 seconds on, .25 seconds off. This will result in a total of 16 blinks.	

Note: Disabled per default BIOS setup option.

4.2 BIOS Error Messages

Table 37 lists the error messages and provides a brief description of each.

Table 37. BIOS Error Messages

Error Message	Explanation
CMOS Battery Low	The battery may be losing power. Replace the battery soon.
CMOS Checksum Bad	The CMOS checksum is incorrect. CMOS memory may have been corrupted. Run Setup to reset values.
Memory Size Decreased	Memory size has decreased since the last boot. If no memory was removed, then memory may be bad.
No Boot Device Available	System did not find a device to boot.

5 Regulatory Compliance and Battery Disposal Information

5.1 Regulatory Compliance

This section contains the following regulatory compliance information for Intel NUC Board DE3815TYBE:

- Safety standards
- European Union Declaration of Conformity statement
- Product Ecology statements
- Electromagnetic Compatibility (EMC) standards
- Product certification markings

5.1.1 Safety Standards

Intel NUC Board DE3815TYBE complies with the safety standards stated in Table 38 when correctly installed in a compatible host system.

Table 38. Safety Standards

Standard	Title
CSA/UL 60950-1	Information Technology Equipment – Safety - Part 1: General Requirements (USA and Canada)
EN 60950-1	Information Technology Equipment – Safety - Part 1: General Requirements (European Union)
IEC 60950-1	Information Technology Equipment – Safety - Part 1: General Requirements (International)

5.1.2 European Union Declaration of Conformity Statement

We, Intel Corporation, declare under our sole responsibility that the products Intel® NUC Board DE3815TYBE is in conformity with all applicable essential requirements necessary for CE marking, following the provisions of the European Council Directive 2004/108/EC (EMC Directive), 2006/95/EC (Low Voltage Directive), and 2002/95/EC (ROHS Directive).

The product is properly CE marked demonstrating this conformity and is for distribution within all member states of the EU with no restrictions.



This product follows the provisions of the European Directives 2004/108/EC, 2006/95/EC, and 2002/95/EC.

Čeština Tento výrobek odpovídá požadavkům evropských směrnic 2004/108/EC, 2006/95/EC a 2002/95/EC.

Dansk Dette produkt er i overensstemmelse med det europæiske direktiv 2004/108/EC, 2006/95/EC & 2002/95/EC.

Dutch Dit product is in navolging van de bepalingen van Europees Directief 2004/108/EC, 2006/95/EC & 2002/95/EC.

Eesti Antud toode vastab Euroopa direktiivides 2004/108/EC, ja 2006/95/EC ja 2002/95/EC kehtestatud nõuetele.

Suomi Tämä tuote noudattaa EU-direktiivin 2004/108/EC, 2006/95/EC & 2002/95/EC määräyksiä.

Français Ce produit est conforme aux exigences de la Directive Européenne 2004/108/EC, 2006/95/EC & 2002/95/EC.

Deutsch Dieses Produkt entspricht den Bestimmungen der Europäischen Richtlinie 2004/108/EC, 2006/95/EC & 2002/95/EC.

Ελληνικά Το παρόν προϊόν ακολουθεί τις διατάξεις των Ευρωπαϊκών Οδηγιών 2004/108/EC, 2006/95/EC και 2002/95/EC.

Magyar E termék megfelel a 2004/108/EC, 2006/95/EC és 2002/95/EC Európai Irányelv előírásainak.

Icelandic Þessi vara stenst reglugerð Evrópska Efnahags Bandalagsins númer 2004/108/EC, 2006/95/EC, & 2002/95/EC.

Italiano Questo prodotto è conforme alla Direttiva Europea 2004/108/EC, 2006/95/EC & 2002/95/EC.

Latviešu Šis produkts atbilst Eiropas Direktīvu 2004/108/EC, 2006/95/EC un 2002/95/EC noteikumiem.

Lietuvių Šis produktas atitinka Europos direktyvų 2004/108/EC, 2006/95/EC, ir 2002/95/EC nuostatas.

Malti Dan il-prodott hu konformi mal-provvedimenti tad-Direttivi Ewropej 2004/108/EC, 2006/95/EC u 2002/95/EC.

Norsk Dette produktet er i henhold til bestemmelsene i det europeiske direktivet 2004/108/EC, 2006/95/EC & 2002/95/EC.

Polski Niniejszy produkt jest zgodny z postanowieniami Dyrektyw Unii Europejskiej 2004/108/EC, 206/95/EC i 2002/95/EC.

Portuguese Este produto cumpre com as normas da Diretiva Europeia 2004/108/EC, 2006/95/EC & 2002/95/EC.

Español Este producto cumple con las normas del Directivo Europeo 2004/108/EC, 2006/95/EC & 2002/95/EC.

Slovensky Tento produkt je v súlade s ustanoveniami európskych direktív 2004/108/EC, 2006/95/EC a 2002/95/EC.

Slovenščina Izdelek je skladen z določbami evropskih direktiv 2004/108/EC, 2006/95/EC in 2002/95/EC.

Svenska Denna produkt har tillverkats i enlighet med EG-direktiv 2004/108/EC, 2006/95/EC & 2002/95/EC.

Türkçe Bu ürün, Avrupa Birliği'nin 2004/108/EC, 2006/95/EC ve 2002/95/EC yönergelerine uyar.

5.1.3 Product Ecology Statements

The following information is provided to address worldwide product ecology concerns and regulations.

5.1.3.1 Disposal Considerations

This product contains the following materials that may be regulated upon disposal: lead solder on the printed wiring board assembly.

5.1.4 EMC Regulations

Intel NUC Board DE3815TYBE complies with the EMC regulations stated in Table 39 when correctly installed in a compatible host system.

Table 39. EMC Regulations

Regulation	Title
FCC 47 CFR Part 15, Subpart B	Title 47 of the Code of Federal Regulations, Part 15, Subpart B, Radio Frequency Devices. (USA)
ICES-003	Interference-Causing Equipment Standard, Digital Apparatus. (Canada)
EN55022	Limits and methods of measurement of Radio Interference Characteristics of Information Technology Equipment. (European Union)
EN55024	Information Technology Equipment – Immunity Characteristics Limits and methods of measurement. (European Union)
EN55022	Australian Communications Authority, Standard for Electromagnetic Compatibility. (Australia and New Zealand)
CISPR 22	Limits and methods of measurement of Radio Disturbance Characteristics of Information Technology Equipment. (International)
CISPR 24	Information Technology Equipment – Immunity Characteristics – Limits and Methods of Measurement. (International)
VCCI V-3, V-4	Voluntary Control for Interference by Information Technology Equipment. (Japan)
KN-22, KN-24	Korean Communications Commission – Framework Act on Telecommunications and Radio Waves Act (South Korea)
CNS 13438	Bureau of Standards, Metrology, and Inspection (Taiwan)

FCC Declaration of Conformity

This device complies with Part 15 of the FCC Rules. Operation is subject to the following two conditions: (1) this device may not cause harmful interference, and (2) this device must accept any interference received, including interference that may cause undesired operation.

For questions related to the EMC performance of this product, contact:

Intel Corporation, 5200 N.E. Elam Young Parkway, Hillsboro, OR 97124
1-800-628-8686

This equipment has been tested and found to comply with the limits for a Class B digital device, pursuant to Part 15 of the FCC Rules. These limits are designed to provide reasonable protection against harmful interference in a residential installation. This equipment generates, uses, and can radiate radio frequency energy and, if not installed and used in accordance with the instructions, may cause harmful interference to radio communications. However, there is no guarantee that interference will not occur in a particular installation. If this equipment does cause harmful interference to radio or television reception, which can be determined by turning the equipment off and on, the user is encouraged to try to correct the interference by one or more of the following measures:

- Reorient or relocate the receiving antenna.
- Increase the separation between the equipment and the receiver.
- Connect the equipment to an outlet on a circuit other than the one to which the receiver is connected.
- Consult the dealer or an experienced radio/TV technician for help.

Any changes or modifications to the equipment not expressly approved by Intel Corporation could void the user’s authority to operate the equipment.

Tested to comply with FCC standards for home or office use.

Canadian Department of Communications Compliance Statement

This digital apparatus does not exceed the Class B limits for radio noise emissions from digital apparatus set out in the Radio Interference Regulations of the Canadian Department of Communications.

Le présent appareil numérique n’émet pas de bruits radioélectriques dépassant les limites applicables aux appareils numériques de la classe B prescrites dans le Règlement sur le brouillage radioélectrique édicté par le ministère des Communications du Canada.

Japan VCCI Statement

Japan VCCI Statement translation: This is a Class B product based on the standard of the Voluntary Control Council for Interference from Information Technology Equipment (VCCI). If this is used near a radio or television receiver in a domestic environment, it may cause radio interference. Install and use the equipment according to the instruction manual.

この装置は、情報処理装置等電波障害自主規制協議会（VCCI）の基準に基づくクラスB 情報技術装置です。この装置は、家庭環境で使用することを目的としていますが、この装置がラジオやテレビジョン受信機に近接して使用されると、受信障害を引き起こすことがあります。
取扱説明書に従って正しい取り扱いをして下さい。

Korea Class B Statement

Korea Class B Statement translation: This equipment is for home use, and has acquired electromagnetic conformity registration, so it can be used not only in residential areas, but also other areas.

이 기기는 가정용(B급) 전자파적합기기로서 주로 가정에서 사용하는 것을 목적으로 하며, 모든 지역에서 사용할 수 있습니다.

5.1.5 e-Standby and ErP Compliance

Intel NUC Board DE3815TYBE meets the following program requirements in an adequate system configuration, including appropriate selection of an efficient power supply:









- EPEAT*
- Korea e-Standby
- European Union Energy-related Products Directive 2013 (ErP) Lot 6

For information about	Refer to
Electronic Product Environmental Assessment Tool (EPEAT)	http://www.epeat.net/
Korea e-Standby Program	http://www.kemco.or.kr/new_eng/pg02/pg02100300.asp
European Union Energy-related Products Directive 2009 (ErP)	http://ec.europa.eu/enterprise/policies/sustainable-business/sustainable-product-policy/ecodesign/index_en.htm

5.1.6 Regulatory Compliance Marks (Board Level)

Intel NUC Board DE3815TYBE has the regulatory compliance marks shown in Table 40.

Table 40. Regulatory Compliance Marks

Description	Mark
UL joint US/Canada Recognized Component mark. Includes adjacent UL file number for Intel NUC Boards: E210882.	
FCC Declaration of Conformity logo mark for Class B equipment.	
CE mark. Declaring compliance to the European Union (EU) EMC directive, Low Voltage directive, and RoHS directive.	
Australian Communications Authority (ACA) and New Zealand Radio Spectrum Management (NZ RSM) C-tick mark. Includes adjacent Intel supplier code number, N-232.	
Japan VCCI (Voluntary Control Council for Interference) mark.	
Korea Certification mark. Includes an adjacent KCC (Korean Communications Commission) certification number: KCC-REM-CPU-DE3815TYBE.	
Taiwan BSMI (Bureau of Standards, Metrology and Inspections) mark. Includes adjacent Intel company number, D33025.	
Printed wiring board manufacturer's recognition mark. Consists of a unique UL recognized manufacturer's logo, along with a flammability rating (solder side).	<p data-bbox="1263 1209 1308 1234">V-0</p>
China RoHS/Environmentally Friendly Use Period Logo: This is an example of the symbol used on Intel NUC Boards and associated collateral. The color of the mark may vary depending upon the application. The Environmental Friendly Usage Period (EFUP) for Intel NUC Boards has been determined to be 10 years.	

5.2 Battery Disposal Information



CAUTION

Risk of explosion if the battery is replaced with an incorrect type. Batteries should be recycled where possible. Disposal of used batteries must be in accordance with local environmental regulations.



PRÉCAUTION

Risque d'explosion si la pile usagée est remplacée par une pile de type incorrect. Les piles usagées doivent être recyclées dans la mesure du possible. La mise au rebut des piles usagées doit respecter les réglementations locales en vigueur en matière de protection de l'environnement.



FORHOLDSREGEL

Eksplodingsfare, hvis batteriet erstattes med et batteri af en forkert type. Batterier bør om muligt genbruges. Bortskaffelse af brugte batterier bør foregå i overensstemmelse med gældende miljølovgivning.



OBS!

Det kan oppstå eksplosjonsfare hvis batteriet skiftes ut med feil type. Brukte batterier bør kastes i henhold til gjeldende miljølovgivning.



VIKTIGT!

Risk för explosion om batteriet ersätts med felaktig batterityp. Batterier ska kasseras enligt de lokala miljövårdsbestämmelserna.



VARO

Räjähdyksvaara, jos pariston tyyppi on väärä. Paristot on kierrätettävä, jos se on mahdollista. Käytetyt paristot on hävitettävä paikallisten ympäristömääräysten mukaisesti.



VORSICHT

Bei falschem Einsetzen einer neuen Batterie besteht Explosionsgefahr. Die Batterie darf nur durch denselben oder einen entsprechenden, vom Hersteller empfohlenen Batterietyp ersetzt werden. Entsorgen Sie verbrauchte Batterien den Anweisungen des Herstellers entsprechend.



AVVERTIMENTO

Esiste il pericolo di un esplosione se la pila non viene sostituita in modo corretto. Utilizzare solo pile uguali o di tipo equivalente a quelle consigliate dal produttore. Per disfarsi delle pile usate, seguire le istruzioni del produttore.



PRECAUCIÓN

Existe peligro de explosión si la pila no se cambia de forma adecuada. Utilice solamente pilas iguales o del mismo tipo que las recomendadas por el fabricante del equipo. Para deshacerse de las pilas usadas, siga igualmente las instrucciones del fabricante.



WAARSCHUWING

Er bestaat ontploffingsgevaar als de batterij wordt vervangen door een onjuist type batterij. Batterijen moeten zoveel mogelijk worden gerecycled. Houd u bij het weggooien van gebruikte batterijen aan de plaatselijke milieuwetgeving.



ATENÇÃO

Haverá risco de explosão se a bateria for substituída por um tipo de bateria incorreto. As baterias devem ser recicladas nos locais apropriados. A eliminação de baterias usadas deve ser feita de acordo com as regulamentações ambientais da região.



AŠCIAROŽNÁŠĆ

Існуе рызыка выбуху, калі заменены акумулятар неправільнага тыпу. Акумулятары павінны, па магчымасці, перепрацоўвацца. Пазбаўляцца ад старых акумулятараў патрэбна згодна з мясцовымі заканадаўствам па экалогіі.



UPOZORNĚNÍ

V případě výměny baterie za nesprávný druh může dojít k výbuchu. Je-li to možné, baterie by měly být recyklovány. Baterie je třeba zlikvidovat v souladu s místními předpisy o životním prostředí.



Προσοχή

Υπάρχει κίνδυνος για έκρηξη σε περίπτωση που η μπαταρία αντικατασταθεί από μία λανθασμένου τύπου. Οι μπαταρίες θα πρέπει να ανακυκλώνονται όταν κάτι τέτοιο είναι δυνατό. Η απόρριψη των χρησιμοποιημένων μπαταριών πρέπει να γίνεται σύμφωνα με τους κατά τόπο περιβαλλοντικούς κανονισμούς.



VIGYÁZAT

Ha a telepet nem a megfelelő típusú telepre cseréli, az felrobbanhat. A telepeket lehetőség szerint újra kell hasznósítani. A használt telepeket a helyi környezetvédelmi előírásoknak megfelelően kell kiselejtezni.



注意

異なる種類の電池を使用すると、爆発の危険があります。リサイクルが可能な地域であれば、電池をリサイクルしてください。使用後の電池を破棄する際には、地域の環境規制に従ってください。



AWAS

Risiko letupan wujud jika bateri digantikan dengan jenis yang tidak betul. Bateri sepatutnya dikitar semula jika boleh. Pelupusan bateri terpakai mestilah mematuhi peraturan alam sekitar tempatan.



OSTRZEŻENIE

Istnieje niebezpieczeństwo wybuchu w przypadku zastosowania niewłaściwego typu baterii. Zużyte baterie należy w miarę możliwości utylizować zgodnie z odpowiednimi przepisami ochrony środowiska.



PRECAUȚIE

Risc de explozie, dacă bateria este înlocuită cu un tip de baterie necorespunzător. Bateriile trebuie reciclate, dacă este posibil. Depozitarea bateriilor uzate trebuie să respecte reglementările locale privind protecția mediului.



ВНИМАНИЕ

При использовании батареи несоответствующего типа существует риск ее взрыва. Батареи должны быть утилизированы по возможности. Утилизация батарей должна проводиться по правилам, соответствующим местным требованиям.



UPOZORNENIE

Ak batériu vymeníte za nesprávny typ, hrozí nebezpečenstvo jej výbuchu. Batérie by sa mali podľa možnosti vždy recyklovať. Likvidácia použitých batérií sa musí vykonávať v súlade s miestnymi predpismi na ochranu životného prostredia.



POZOR

Zamenjava baterije z baterijo drugačnega tipa lahko povzroči eksplozijo. Če je mogoče, baterije reciklirajte. Rabljene baterije zavržite v skladu z lokalnimi okoljevarstvenimi predpisi.



คำเตือน

ระวังการระเบิดที่เกิดจากเปลี่ยนแบตเตอรี่ผิดประเภท หากเป็นไปได้ ควรนำแบตเตอรี่ไปรีไซเคิล การทิ้งแบตเตอรี่ใช้แล้วต้องเป็นไปตามกฎข้อบังคับด้านสิ่งแวดล้อมของท้องถิ่น.



UYARI

Yanlış türde pil takıldığında patlama riski vardır. Piller mümkün olduğunda geri dönüştürülmelidir. Kullanılmış piller, yerel çevre yasalarına uygun olarak atılmalıdır.



ОСТОРОГА

Використовуйте батареї правильного типу, інакше існуватиме ризик вибуху. Якщо можливо, використані батареї слід утилізувати. Утилізація використаних батарей має бути виконана згідно місцевих норм, що регулюють охорону довкілля.



UPOZORNĚNÍ

V případě výměny baterie za nesprávný druh může dojít k výbuchu. Je-li to možné, baterie by měly být recyklovány. Baterie je třeba zlikvidovat v souladu s místními předpisy o životním prostředí.



ETTEVAATUST

Kui patarei asendatakse uue ebasobivat tüüpi patareiga, võib tekkida plahvatusoht. Tühjad patareid tuleb võimaluse korral viia vastavasse kogumispunkti. Tühjade patareide äraviskamisel tuleb järgida kohalikke keskkonnakaitse alaseid reegleid.



FIGYELMEZTETÉS

Ha az elemet nem a megfelelő típusúra cseréli, felrobbanhat. Az elemeket lehetőség szerint újra kell hasznosítani. A használt elemeket a helyi környezetvédelmi előírásoknak megfelelően kell kiselejtezni.



UZMANĪBU

Pastāv eksplozijas risks, ja baterijas tiek nomainītas ar nepareiza veida baterijām. Ja iespējams, baterijas vajadzētu nodot attiecīgos pieņemšanas punktus. Bateriju izmešanai atkritumos jānotiek saskaņā ar vietējiem vides aizsardzības noteikumiem.



DĒMESIO

Naudojant netinkamo tipo baterijas įrenginys gali sprogti. Kai tik įmanoma, baterijas reikia naudoti pakartotinai. Panaudotas baterijas išmesti būtina pagal vietinius aplinkos apsaugos nuostatus.



ATTENZJONI

Riskju ta' splużjoni jekk il-batterija tinbidel b'tip ta' batterija mhux korrett. Il-batteriji għandhom jiġu riċiklati fejn hu possibbli. Ir-rimi ta' batteriji użati għandu jsir skond ir-regolamenti ambjentali lokali.



OSTRZEŻENIE

Ryzyko wybuchu w przypadku wymiany na baterie niewłaściwego typu. W miarę możliwości baterie należy poddać recyklingowi. Zużytych baterii należy pozbywać się zgodnie z lokalnie obowiązującymi przepisami w zakresie ochrony środowiska.

