

User's Manual

CNPS10X Quiet

Intel Socket 1366/1156/775 CPU

- Core i7
- Core 2 Quad
- Core 2 Duo
- Core 2 Extreme
- Dual Core Pentium
- Pentium D
- Pentium 4
- Celeron D

AMD Socket AM3/AM2+/AM2/754/939/940 CPU

- Phenom II
- Phenom
- Athlon 64 FX
- Athlon 64 X2 Dual-Core
- Athlon 64
- Opteron
- Opteron Dual-Core
- Sempron

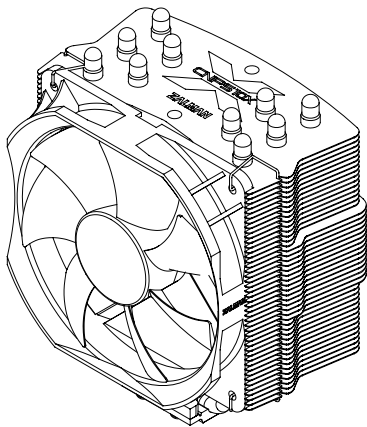

To ensure safe and easy installation,
please read the following precautions.

<http://www.zalman.com>

1. Precautions

- 1) Use and keep product away from reach of children and pets.
- 2) Do not ingest the Thermal Grease, and avoid its contact with skin and eyes. If contact is made with skin, wash off with water. If ingested or irritation persists, seek medical attention.
- 3) To prevent possible injuries, gloves must be worn while handling this product.
- 4) Excessive force exerted on the fan may cause damage to the fan and/or system.
- 5) Avoid inserting objects or hands into the fan while it is in operation to prevent product damage and injuries.
- 6) Check the components list and condition of the product before installation. If any problem is found, contact the retailer to obtain a replacement.
- 7) Zalman Tech Co., Ltd. is not responsible for any damages due to overclocking.
- 8) During transportation of the system, the cooler must be removed. Zalman is not responsible for any damages that occur during the transport of a system.
- 9) Product design and specifications may be revised to improve quality and performance.

Disclaimer) Zalman Tech Co., Ltd. is not responsible for any damages due to external causes, including but not limited to, improper use, problems with electrical power, accident, neglect, alteration, repair, improper installation, or improper testing.

2. Specifications

Spec.		Model	CNPS10X Quiet
Materials			Pure Aluminum and Pure Copper
Weight			750g
Dimensions			135(L) X 100(W) X 160(H)mm
Fan	Bearing		2 Ball-Bearing
	RPM		700 ~ 1400 rpm $\pm 10\%$ (w/ Fan Mate2)
	Noise Level		Not Measurable ~ 26 dBA $\pm 10\%$ (w/ Fan Mate2)
	Input Voltage		12V
Fan Mate 2	Output Voltage		5 ~ 11V $\pm 10\%$
	Load Tolerance		below 6W
Thermal Grease (ZM-STG2)	Contents		3.5g
	Temp Range		-40°C ~ +150°C (-40 ~ +302°F)

※ The fan operates at 1500 rpm $\pm 10\%$ (28 dBA $\pm 10\%$) if directly connected to the motherboard's power connector without the use of Fan Mate 2.

3. Components

1) Common Components

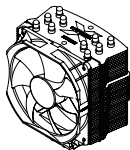

Cooler



Washers



Thermal Grease
(ZM-STG2)



Double-Sided
Tape



Fan Mate 2



Fan Mate 2
Cable

Manual

User's Manual

2) Intel Socket 1156/775 Components

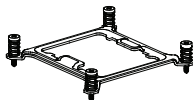

Socket 1156/775 Clip

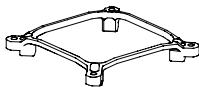

Socket 1156/775
Clip Support



Socket 775
Backplate



Socket 1156 Nuts

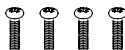

Bolts (Silver)

3) Intel Socket 1366 Components

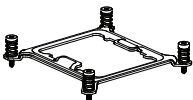

Socket 1366 Clip

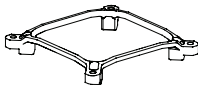

Socket 1366
Clip Support

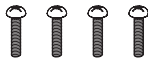

Bolts (Gold)

4) AMD Socket AM3/AM2+/AM2/754/939/940 Components

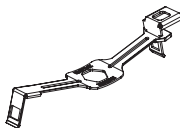

AMD Clip

4. Installation Requirements

1) Space Requirements

The cooler's installation requires unobstructed space with dimensions of 140mm(width), 140mm(length), 165mm(height), and the CPU as a central reference point. Please check if components such as ODDs and PSU protrude into the required space.

2) Air Guide Removal

Air guides on enclosures must be removed, before the cooler's installation, for they protrude into the cooler's required space.

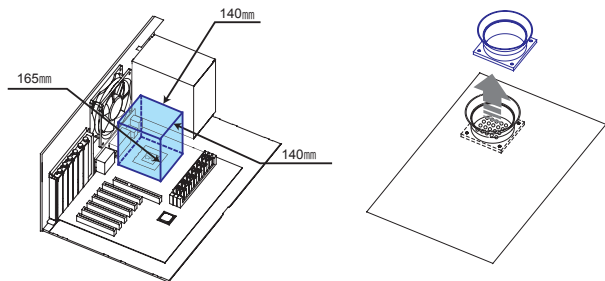

5. Installation

1) Intel Socket 1156/775 and Socket 1366 Installation

① - A Socket 775 Clip Support Installation

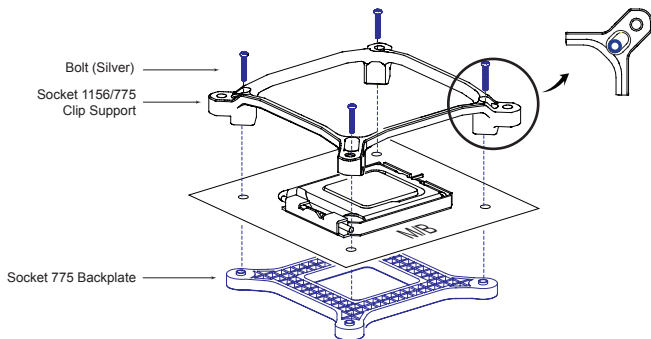

① - B Socket 1156 Clip Support Installation

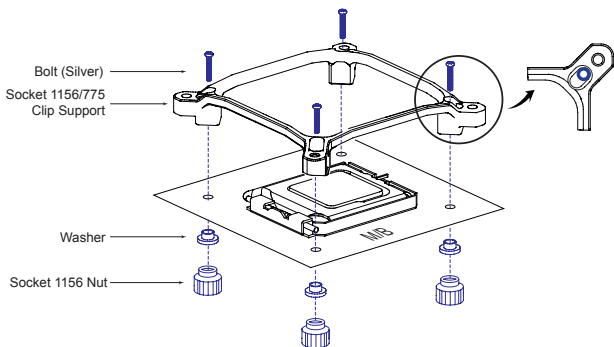

① - C Socket 1366 Clip Support Installation

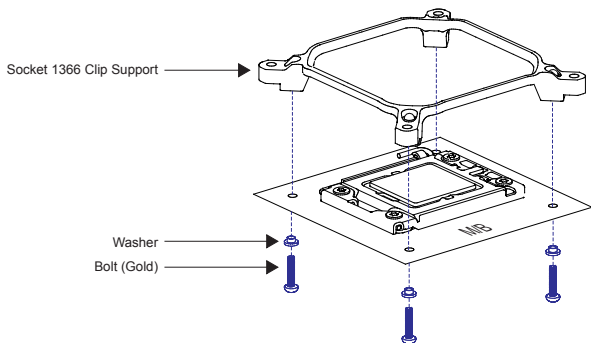

- ② Clear off any particles or residue from the CPU's surface then spread (outwards from center) a thorough layer of Thermal Grease on the CPU and the base of the cooler.

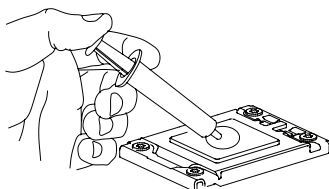

- ③ Remove the Fan from the Heatsink by unfastening the Fan Fixing Clip.

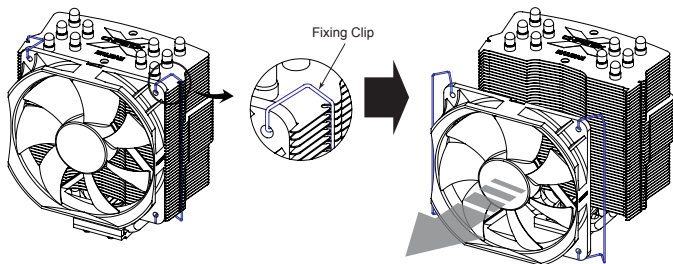

- ④ Insert the Intel Socket 1156/775 or Socket 1366 Clip through the cooler's heatpipes at an odd angle then center its orientation. Making sure that the cooler and the clip are centered, fasten the clip by tightening the Intel Socket Clip Fixing Bolts.

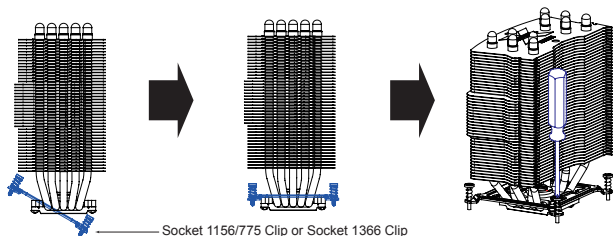

Tip

Thread the Bolts one rotation at a time for easy installation.



Warning

Make sure the Clip is centered for flush installation.

- ⑤ Use the Fixing Clip to fasten the Fan to the Heatsink.

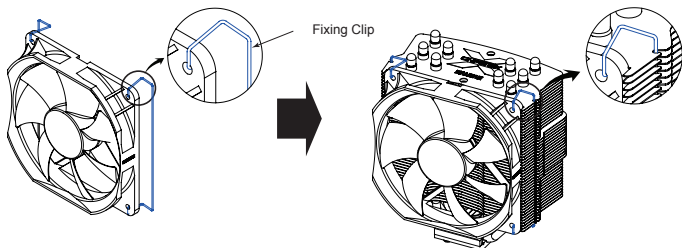

- ⑥ Power Connection

※ Refer to page 7 for Fan Mate 2 installation

2) AMD Socket AM3/AM2+/AM2/754/939/940 Installation

- ① Clear off any particles or residue from the CPU's surface then spread (outwards from center) a thorough layer of Thermal Grease on the CPU and the base of the cooler.

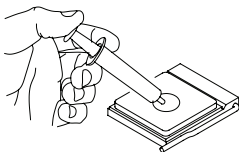

- ② Place the cooler on the center of the CPU. Align and connect the Clip's Lug Slot with the Lug of the motherboard's retention frame. Press onto the Clip Lever when aligning the Lever's Lug Slot with the Lug.

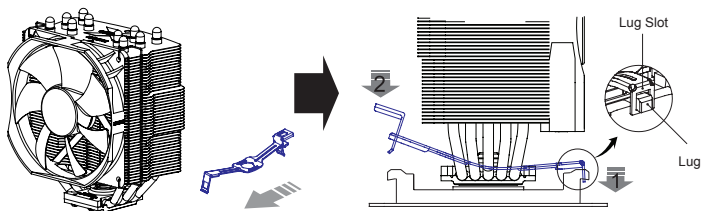

- ③ Power Connection

※ Refer to page 7 for Fan Mate 2 installation

6. Fan Mate 2 Installation and Usage

1) Fan Mate 2 Installation

- ① Connect the motherboard and Fan Cable to the Fan Mate 2 as shown in the diagram below.

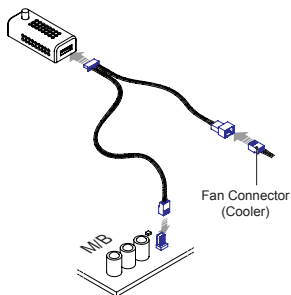

- ② Fan Mate 2 can be installed to the side of the case using Double-Sided Tape.

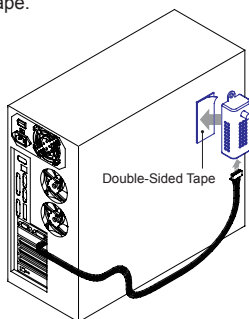

2) Fan Mate 2 Usage

Rotating the Fan Speed Control Knob for RPM control.

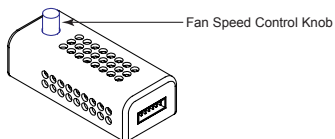

BIOS booting error

In the case that you get a BIOS error beep:

- ① Rotate the Fan Speed Control Knob to the maximum setting.
- ② Disable CPU Fan Detected in BIOS setting or set the system monitoring program's CPU Fan RPM to the lowest setting.

※ Certain motherboards will not boot if the CPU fan's RPM is not detected. In this case inquire to the motherboard's manufacturer for additional details.

